

AKCESORIA MEBLOWE[®]
KATARZYŃKI
PRODUCENT

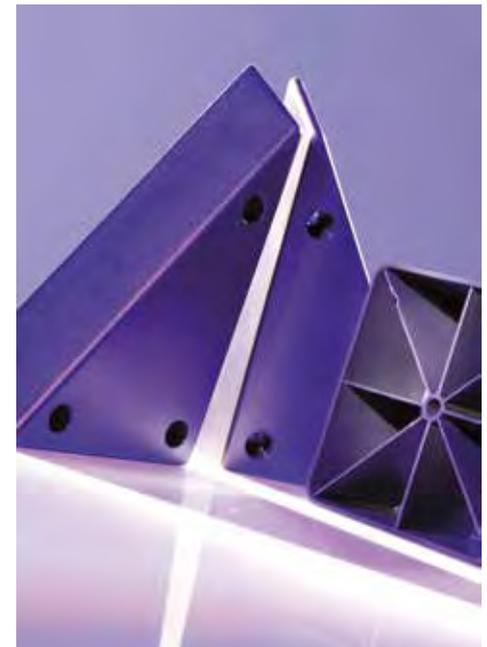

KATALOG
2013/2014



Budujemy
solidne podstawy



Firma Haliny Błażejowicz to firma o rodzinnym charakterze, która oferuje Państwu:

- 25 lat doświadczenia w zakresie produkcji;
- działanie w grupie zrzeszającej 3 firmy;
- zróżnicowany park maszynowy, który stanowią m.in. 26 wtryskarek z automatycznym systemem zasypywania, laser wodny, giętarka;
- szeroka oferta obejmująca zarówno asortyment z tworzyw sztucznych, a także detale metalowe oraz drewniane;

- własny dział projektowo-wdrożeniowy;
- nowoczesna linia lakiernicza;
- indywidualne podejście do ofertyzacji i prowadzonych projektów;
- modyfikowanie standardowej oferty pod indywidualne potrzeby klienta;
- bezpośrednia opieka przedstawicieli handlowych;
- krótkie terminy realizacji;
- regularne dostawy do klienta.

Zapraszamy do współpracy





Die Firma von Halina Błażejowicz ist ein Familienunternehmen und hat Ihnen folgendes anzubieten :

- 25-jährige Erfahrung im Bereich der Produktion;
- Kooperation in einer Gruppe von 3 Firmen;
- differenzierten Maschinenpark;
- 26 Einspritzmaschinen mit einem automatischen Nachfüllgerät, Wasserstrahl-Laser, Biegemaschine ... ;
- Sortiment aus Kunststoffen und aus Metall;
- eigene Designer- und Projektausführungsabteilung;
- moderne Lackierungslinie;
- individuelle Herangehensweise bei Angebotsgestaltung;
- modifizierende Anpassung des Standardangebots an die individuellen Bedürfnisse der Kundschaft;
- direkte Betreuung durch unsere Handelsvertreter;
- kurze Realisierungstermine für Aufträge;
- regelmäßige Lieferungen an Kunden.

Wir laden Sie zur Mitarbeit ein.



The Company owned by Halina Błażejowicz is a family business und offers the following to you :

- 25 years of experience in the production;
- cooperative activity of a group composed of 3 firms;
- highly differentiated machinery;
- 26 injection moulders with an automatic refill, water laser, bending machine ... ;
- rich assortment of plastic materials and metal products;
- our own designer and implementation department;
- modern, state-of-the-art varnishing line;
- individual approach to commercial offer;
- flexible adjustment of the standard offer to individual needs of the customer;
- direct care and support by our sales representatives;
- short delivery deadlines;
- regular deliveries to the customer.

We invite you to cooperation.

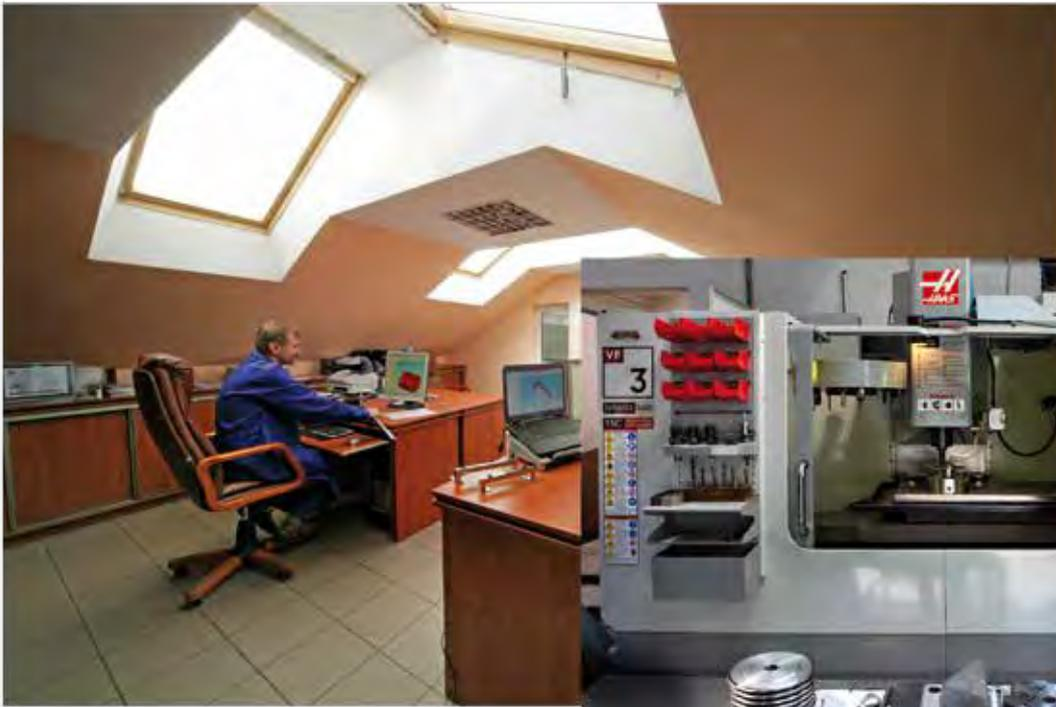

Фирма Халины Блажевич – это семейное предприятие, которое предлагает Вам:

- 25 лет опыта в отрасли производства пластмассовых изделий;
- деятельность в группе включающей 3 фирмы;
- богатый машинный парк;
- 26 литьевых прессов с системой автоматического управления шихтой, водный лазер, гибочная машина;
- ассортимент пластмассовых и металлических изделий;

- собственный проектно-внедрительный отдел;
- современная лакировальная линия;
- индивидуальный подход с учетом всех требований;
- модификация стандартного предложения к индивидуальным нуждам клиента;
- непосредственные контакты с торговыми представителями;
- короткие сроки реализации;
- регулярные поставки к клиентам.

Приглашаем к сотрудничеству!



Lakierowanie UV

UV coating

UV-Lack

UV лакирование





Dysponujemy wysoko zaawansowaną technicznie linią do metalizacji próżniowej i pokrywania lakierami UV. Ofertę naszą kierujemy do przemysłu meblowego, motoryzacyjnego, kosmetycznego, chemicznego, spożywczego, zabawkarskiego oraz do zdobienia różnego rodzaju opakowań, wyrobów galanteryjnych z tworzyw sztucznych, szkła i metalu. Powłoki są wykonywane w wersji metalicznej z połyskiem, matowe, perłowe w szerokiej gamie kolorów oraz transparente wg indywidualnych życzeń Klientów.

We have at our disposal a technically highly advanced production line for vacuum metallization and for UV coating. Our offer is addressed to manufacturers of furniture and a number of other industries : automotive, cosmetic, chemical, food and toy industries. The technology is also well-suited for decorating all kinds of packages and fancy goods made of plastic materials, of glass or metal. The coating is obtainable in several variations optionally: metallic sheen, with full gloss or lustreless, nacreous, and in a wide range of colours, but transparent as well, according to individual wishes of our customers.



Wir verfügen über eine technisch weit fortgeschrittene Linie für die Vakuum-Metallisierung und für die Beschichtung mit UV-Lack. Unser Angebot richten wir an verschiedenste Industriezweige: Möbelindustrie, Autoindustrie, kosmetische, chemische, Lebensmittel- und Spielzeugindustrie. Die von uns angewandte Technologie eignet sich ebenfalls hervorragend zur Verzierung von aller Art Verpackungen, Galanteriewaren aus Kunststoff, aus Glas und Metall. Die Beschichtungen werden in metallischer Version glänzend oder matt, perlmuttartig in breiter Farbpalette oder durchsichtig entsprechend den individuellen Wünschen der Kundschaft ausgeführt.

В нашем распоряжении технически подвинутая линия вакуумного напыления и покрытия УФ-лаками. Наше предложение направлено главным образом к производителям мебельных и автомобильных изделий, к косметической, химической, продовольственной и игрушечной промышленности, а также к изготовителям разного типа упаковок с целью их украшения и в производстве галантерейных изделий из пластмасс, стекла и металла. Покрытие возможно в металлической, матовой, перламутровой версиях, в широкой гамме цветов, а также прозрачные, по индивидуальному желанию клиентов.





chrom

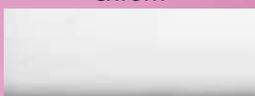

satyna



satyna ciemna



Wyroby z tworzyw sztucznych metalizowane TW-M

Plastic metallized furniture accessories
Kunststoffteile metaliesiert
Изделия металлизированные из пластмасс



| Nr katalogowy ■ Nowość | H | φ | H1 |
|---------------------------|-----|----|----|
| TW-M 1009.02 | 60 | 50 | 30 |
| TW-M 1151 | 90 | 50 | 35 |
| TW-M 1146 | 100 | 60 | 35 |
| TW-M 1005 | 100 | 50 | 35 |
| TW-M 1001 | 110 | 50 | 35 |
| TW-M 1146.01 | 120 | 60 | 35 |
| TW-M 1003 | 120 | 50 | 35 |
| TW-M 1183 | 130 | 50 | 35 |
| TW-M 1002 | 135 | 50 | 35 |
| TW-M 1146.02 | 150 | 60 | 35 |
| TW-M 1165 | 150 | 50 | 35 |
| ■ TW-M 1183.02 | 160 | 50 | 25 |

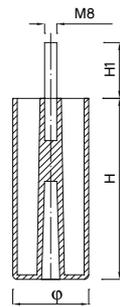

| Nr katalogowy | H |
|---------------|----|
| TW-M 1023 | 70 |
| TW-M 1004 | 80 |

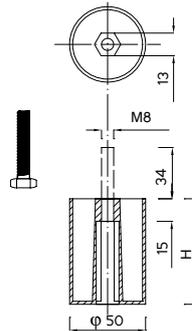

TW-M 1020.02

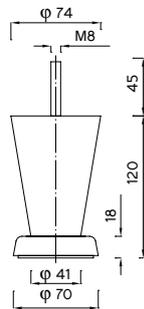

TW-M 1020

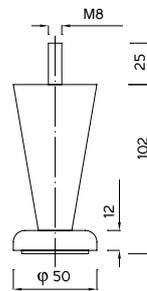

TW-M 1036

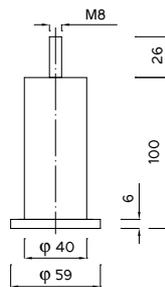

| Nr katalogowy | H |
|---------------|-----|
| TW-M 1115 | 90 |
| TW-M 1114 | 100 |
| TW-M 1099 | 120 |
| TW-M 1051 | 140 |

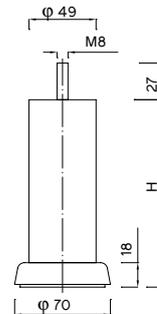

| Nr katalogowy | H | H1 |
|---------------|-----|----|
| TW-M 1019.02 | 50 | 25 |
| TW-M 1062.01 | 100 | 30 |
| TW-M 1063 | 100 | 25 |
| TW-M 1062 | 100 | 35 |
| TW-M 1019 | 110 | 25 |
| TW-M 1063.05 | 150 | 30 |

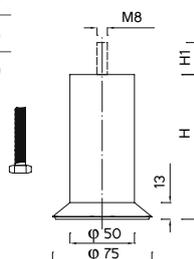

| Nr katalogowy | H | H1 |
|---------------|-----|----|
| TW-M 1186 | 50 | 15 |
| TW-M 1076 | 100 | 25 |
| TW-M 1075 | 110 | 25 |
| TW-M 1075.02 | 150 | 30 |

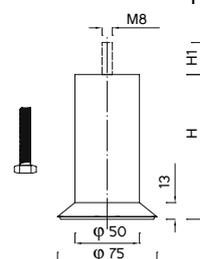



TW-M



| Nr katalogowy | H |
|---------------|-----|
| TW-M 1121.02 | 85 |
| TW-M 1121.01 | 100 |
| TW-M 1121 | 140 |

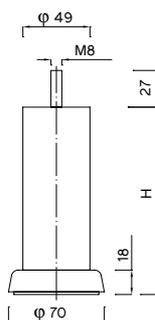
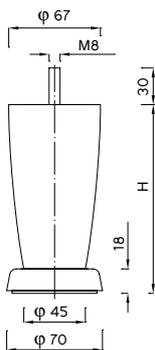

| Nr katalogowy | H |
|---------------|-----|
| TW-M 1113 | 90 |
| TW-M 1112 | 100 |
| TW-M 1098 | 120 |
| TW-M 1027 | 140 |



TW-M 1061

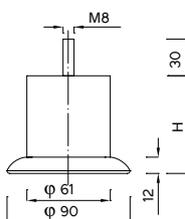
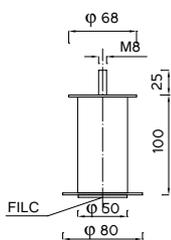

| Nr katalogowy | H |
|---------------|-----|
| TW-M 1096 | 70 |
| TW-M 1096.02 | 90 |
| TW-M 1096.03 | 100 |



TW-M 1201.03

New

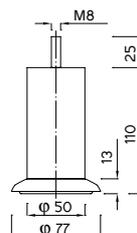
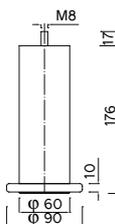

TW-M 1091



| Nr katalogowy | φ | H | H1 |
|---------------|-----|-----|----|
| TW-M 1037 | 80 | 60 | 20 |
| TW-M 1137 | 80 | 80 | 35 |
| TW-M 1014 | 80 | 100 | 25 |
| TW-M 1158 | 80 | 70 | 20 |
| TW-M 1142.01 | 100 | 80 | 20 |
| TW-M 1142 | 100 | 100 | 25 |
| TW-M 1059 | 100 | 120 | 25 |
| TW-M 1012 | 100 | 120 | 40 |

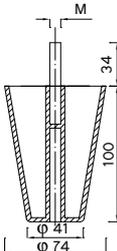
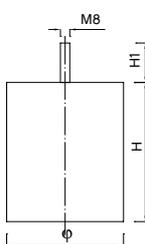

| Nr katalogowy | M |
|---------------|----|
| TW-M 1015 | 8 |
| TW-M 1016 | 10 |





| Nr katalogowy | H |
|---------------|-----|
| TW-M 1162.01 | 90 |
| TW-M 1162 | 100 |
| TW-M 1162.02 | 110 |

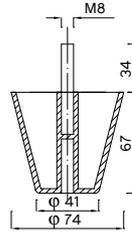
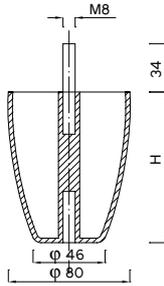

TW-M 1025



| Nr katalogowy | H |
|---------------|----|
| TW-M 1102 | 64 |
| TW-M 1102.01 | 82 |
| TW-M 1102.02 | 92 |

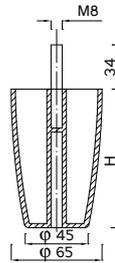
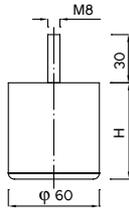

| Nr katalogowy | H |
|--|-----|
| TW-M 1148 | 70 |
| ■ TW-M 1211 | 82 |
| TW-M 1010 | 88 |
| TW-M 1011 | 120 |
| TW-M 1011.01 | 130 |



| Nr katalogowy | H |
|---------------|----|
| TW-M 1006 | 25 |
| TW-M 1007 | 35 |
| TW-M 1031 | 40 |
| TW-M 1008 | 50 |
| TW-M 1009 | 60 |

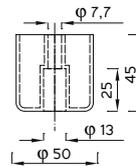
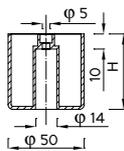

TW-M 1177.02

New



TW-M 1026

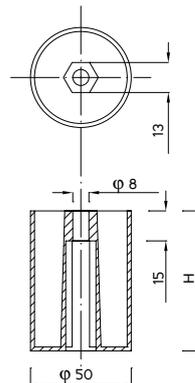
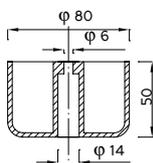

| Nr katalogowy | H |
|---------------|----|
| TW-M 1023.01 | 70 |
| TW-M 1038.01 | 80 |





TW-M

TW-M 1058.01

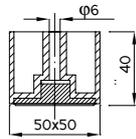

TW-M 1058

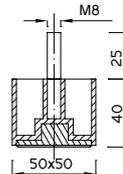

TW-M 1139

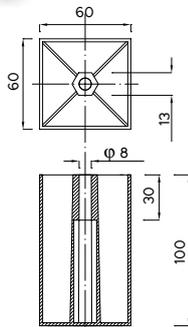

TW-M 1139.06

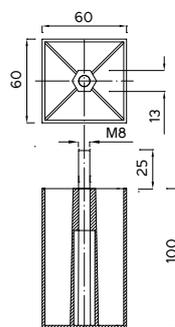

| Nr katalogowy | H | L | L1 | H1 |
|---------------------|-----|-----|----|----|
| TW-M 1018 | 60 | 105 | 80 | 40 |
| TW-M 1135.05 | 67 | 100 | 80 | 32 |
| TW-M 1135 | 80 | 100 | 80 | 45 |
| TW-M 1021 | 100 | 100 | 75 | 45 |

TW-M 1199

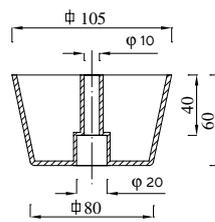
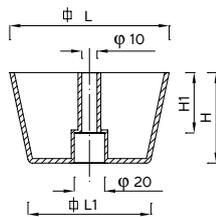

| Nr katalogowy | H | L | L1 | H1 |
|---------------|-----|-----|----|----|
| TW-M 1060.03 | 60 | 105 | 80 | 40 |
| TW-M 1060.06 | 80 | 100 | 80 | 45 |
| TW-M 1060 | 100 | 100 | 75 | 45 |

| Nr katalogowy | H | L | L1 | H1 |
|---------------|-----|-----|----|----|
| TW-M 1060.05 | 60 | 105 | 80 | 40 |
| TW-M 1060.04 | 80 | 100 | 80 | 45 |
| TW-M 1060.01 | 100 | 100 | 75 | 45 |

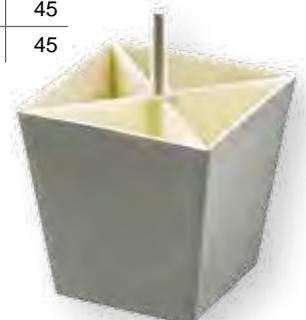
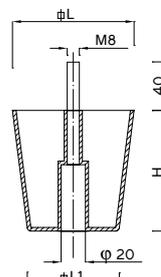
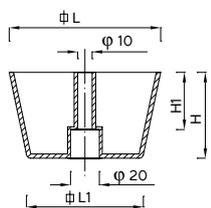

| Nr katalogowy | H | L | L1 | H1 |
|---------------|-----|-----|----|----|
| TW-M 1163 | 80 | 100 | 80 | 45 |
| TW-M 1163.01 | 100 | 100 | 75 | 45 |

TW-M 1194

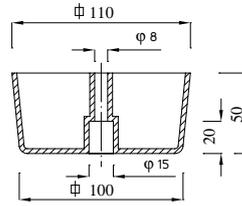
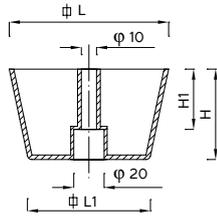

TW-M 1172

| Nr katalogowy | H |
|---------------|----|
| TW-M 1153 | 45 |
| TW-M 1153.02 | 55 |

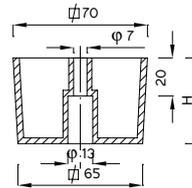
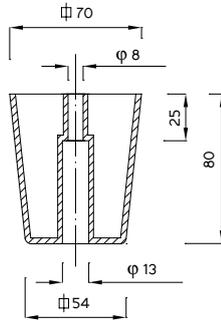

TW-M 1144

TW-M 1145

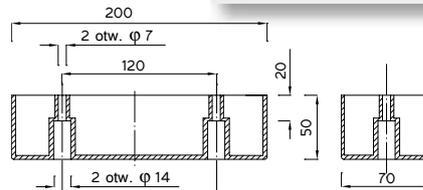
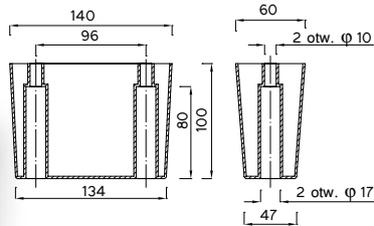

| Nr katalogowy | L1 | L2 | L3 | H |
|---------------|-----|-----|-----|----|
| TW-M 1171 | 160 | 150 | 65 | 50 |
| TW-M 1039 | 160 | 151 | 65 | 67 |
| TW-M 1164 | 200 | 190 | 120 | 67 |
| TW-M 1044 | 280 | 270 | 192 | 67 |
| TW-M 1134 | 320 | 310 | 232 | 67 |

TW-M 1181 (satyna)

TW-M 1181.01 (chrom)

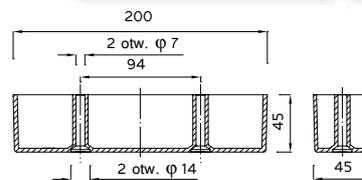
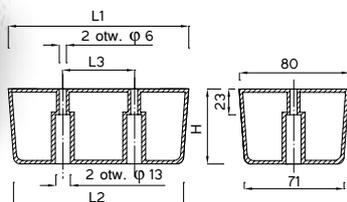



TW-MI

TW-M 1159



Noga prawa i lewa

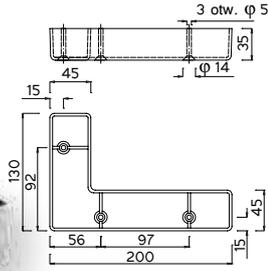

TW-M 1138 (satyna)

TW-M 1138.09 (chrom)

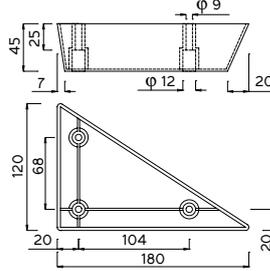

Noga prawa i lewa

TW-M 1207

New

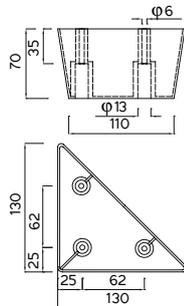

TW-M 1208.01

New

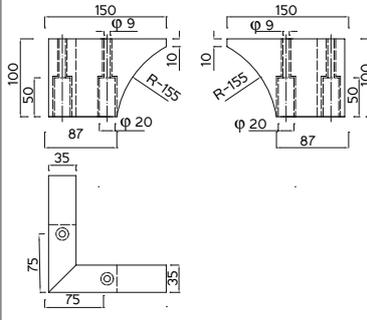

| Nr katalogowy | L |
|----------------|-----|
| ■ Nowość | |
| ■ TW-M 1204 | 225 |
| ■ TW-M 1204.04 | 200 |

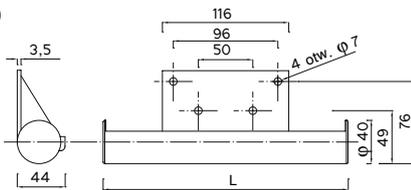

| Nr katalogowy | L |
|----------------|-----|
| ■ Nowość | |
| ■ TW-M 1204.03 | 150 |
| ■ TW-M 1204.02 | 100 |

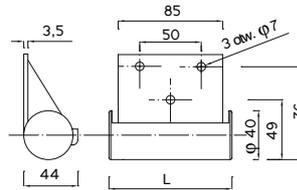

TW-M 1193.01

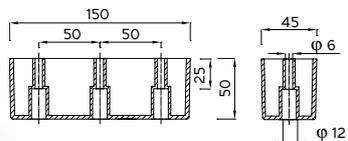
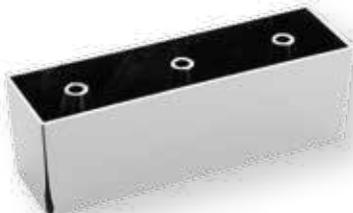

TW-M 1202

New

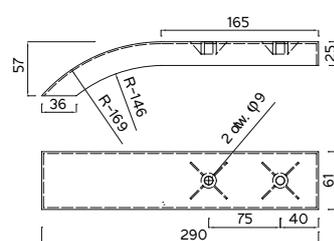



TW-M 1173

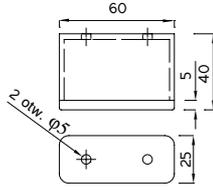

TW-M 1178

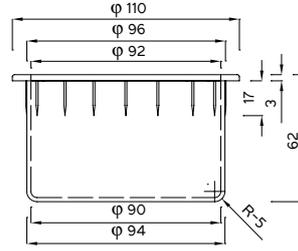

TW-M 1015.02

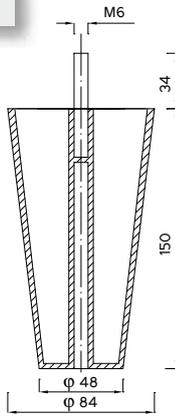

TW-M 1195

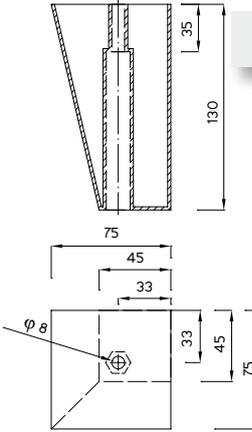

| Nr katalogowy | H |
|----------------|----|
| ■ Nowość | |
| TW-M 1192 | 50 |
| ■ TW-M 1154.01 | 45 |

TW-M 1160.01

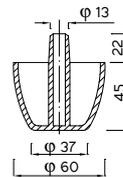
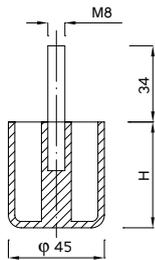

TW-M 1143.01

TW-M 1200

New

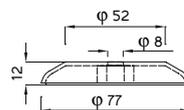
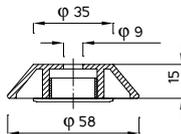



TW-M

TW-M 7508

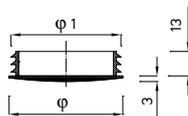
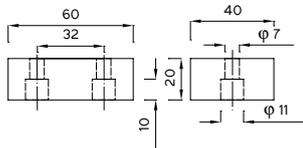

| Nr katalogowy | φ | φ 1 |
|---------------|----|-----|
| TW-M 1129 | 40 | 37 |
| TW-M 1057 | 50 | 47 |
| TW-M 1030 | 60 | 57 |

TW-M 1205

New

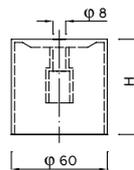
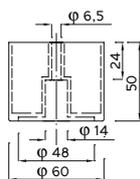

| Nr katalogowy | H |
|---------------|----|
| TW-M 1102.03 | 64 |
| TW-M 1102.05 | 78 |
| TW-M 1102.04 | 90 |

TW-M 1167

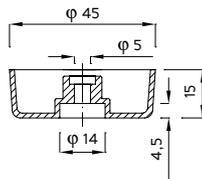

TW-M 1161

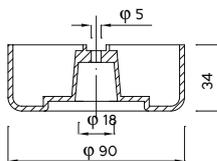

TW-M 1125.04

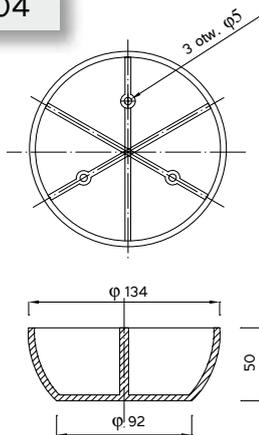

TW-M 1124.01

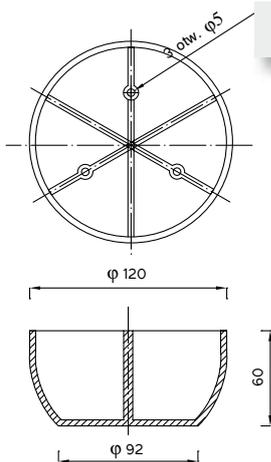

buk



dąb



olcha

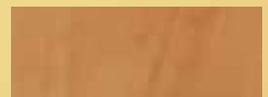

świerk

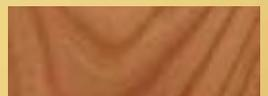

Wyroby z tworzyw sztucznych drewnopodobne TW-M

Plastic wood-effect furniture accessories
Kunststoffteile holzähnlich
Изделия из пластмасс с имитацией древесины



W-MI

| Nr katalogowy | H |
|---------------|-----|
| TW-M 1151.01 | 90 |
| TW-M 1109 | 100 |
| TW-M 1110 | 110 |
| TW-M 1033 | 120 |
| TW-M 1111 | 135 |

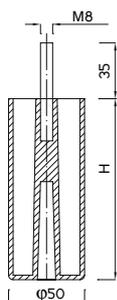

| Nr katalogowy | H |
|---------------|-----|
| TW-M 1105 | 120 |
| TW-M 1048 | 140 |

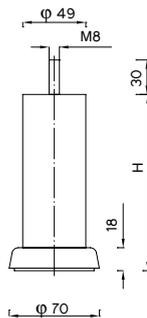

| Nr katalogowy | H |
|---------------|----|
| TW-M 1107 | 70 |
| TW-M 1108 | 80 |

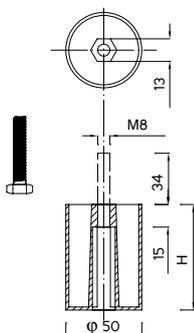

| Nr katalogowy | H |
|---------------|-----|
| TW-M 1148.01 | 70 |
| TW-M 1103 | 88 |
| TW-M 1104 | 120 |
| TW-M 1011.02 | 130 |

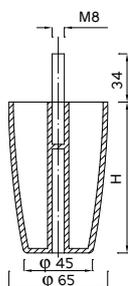

TW-M 1090.01

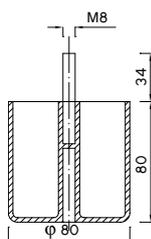

TW-M 1123

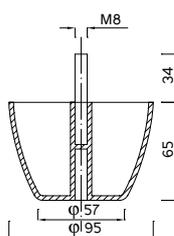

| Nr katalogowy | H |
|---------------|-----|
| TW-M 1116 | 90 |
| TW-M 1117 | 100 |
| TW-M 1118 | 110 |

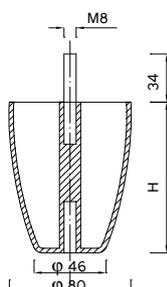

TW-M 1025.01

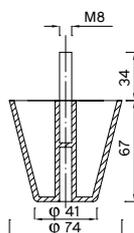



| Nr katalogowy | H |
|---------------|----|
| TW-M 1042 | 70 |
| TW-M 1042.01 | 80 |

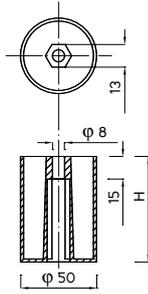

| Nr katalogowy | H |
|---------------|----|
| TW-M 1041.02 | 40 |
| TW-M 1041 | 50 |
| TW-M 1041.01 | 60 |

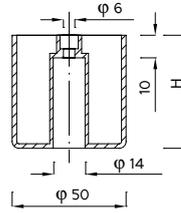

TW-M 7038.06

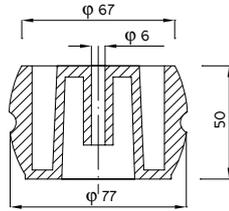

TW-M 7039.05

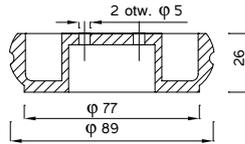

TW-M 1169

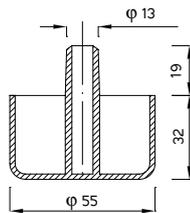

| Nr katalogowy | H | φ D |
|---------------|----|-----|
| TW-M 1160 | 22 | 13 |
| TW-M 1160.02 | 11 | 10 |
| TW-M 1160.03 | 22 | 10 |

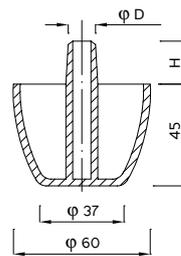

TW-M 1125

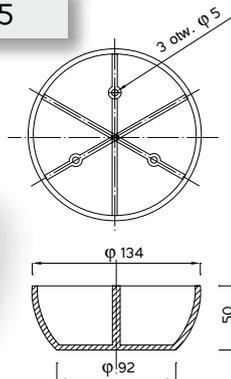

TW-M 1131

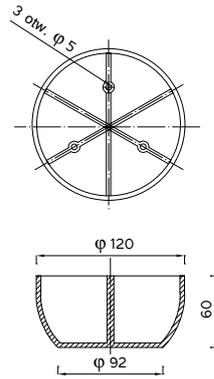



TW-M

TW-M 1097

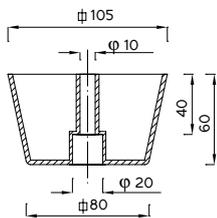
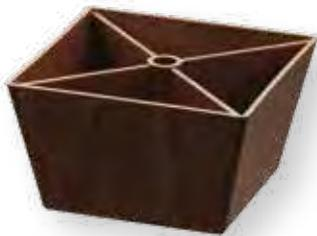

TW-M 1097.01

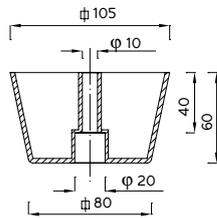

| Nr katalogowy | H | L | L1 | H1 |
|---------------|-----|-----|----|----|
| TW-M 1052 | 60 | 105 | 80 | 40 |
| TW-M 1056 | 100 | 100 | 75 | 45 |

TW-M 1050

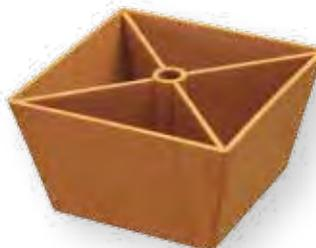
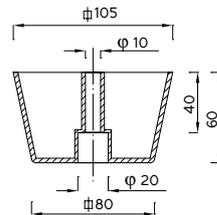
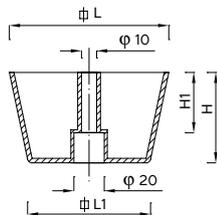
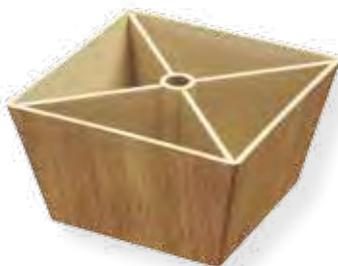

TW-M 1035

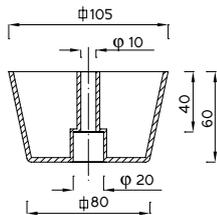
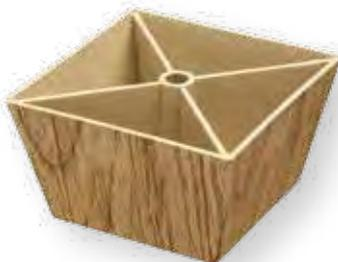

TW-M 1056.02

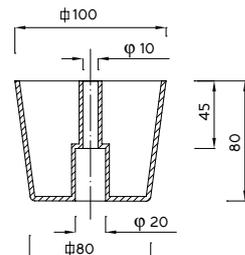
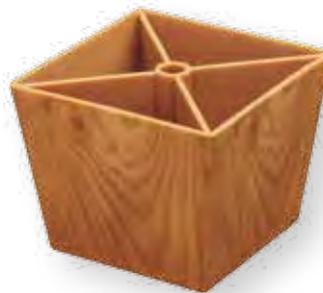

TW-M 1034

| Nr katalogowy | H | L | L1 | H1 |
|---------------|-----|-----|----|----|
| TW-M 1053.03 | 80 | 100 | 80 | 45 |
| TW-M 1053.02 | 100 | 100 | 75 | 45 |

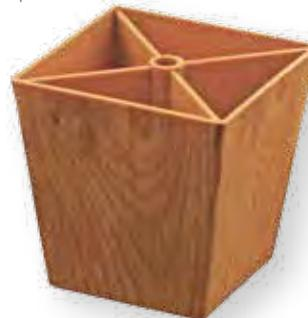
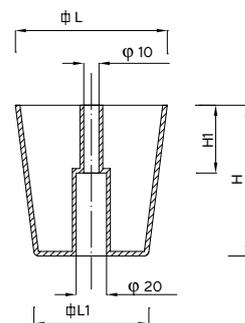
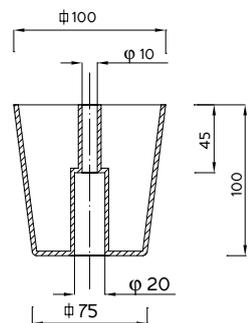
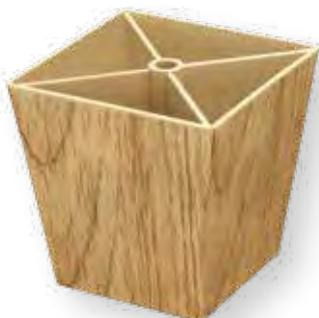



TW-M 1022

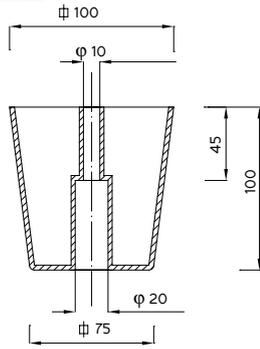
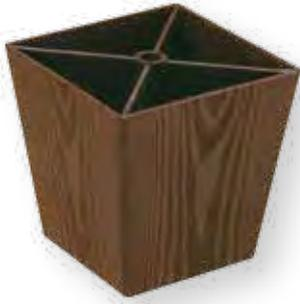

TW-M 1040

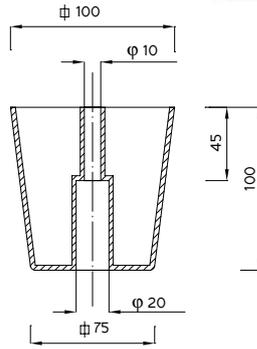
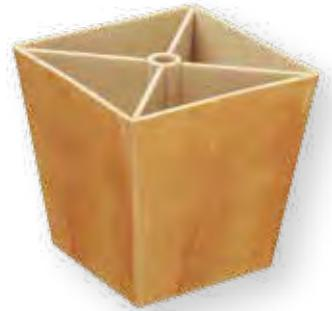

TW-M 1153.01

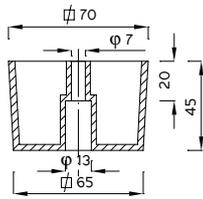

TW-M 1179

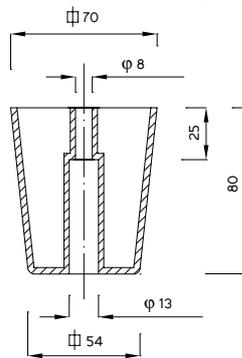

TW-M 1182

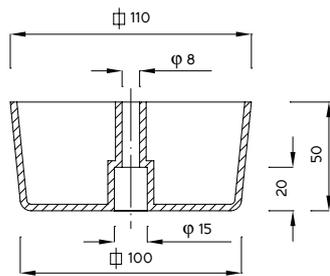

TW-M 1150

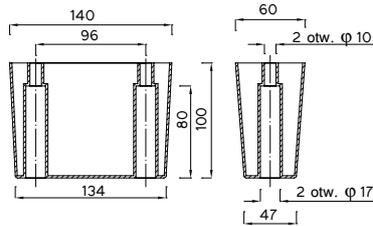

TW-M 1196

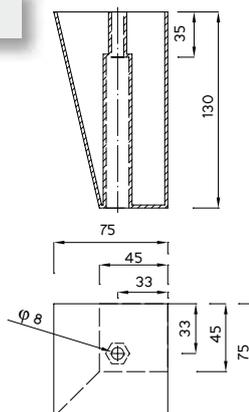

TW-M 1139.03

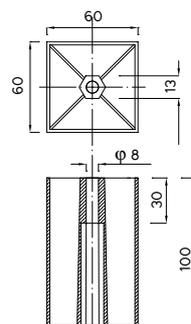



TW-MI

| Nr katalogowy | L1 | L2 | L3 | H |
|---------------|-----|-----|-----|----|
| TW-M 1184 | 160 | 150 | 65 | 50 |
| TW-M 1055 | 160 | 151 | 65 | 67 |
| TW-M 1166 | 200 | 190 | 120 | 67 |
| TW-M 1055.03 | 280 | 270 | 192 | 67 |
| TW-M 1055.04 | 320 | 310 | 232 | 67 |

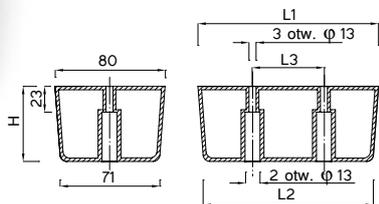

TW-M 1145.01

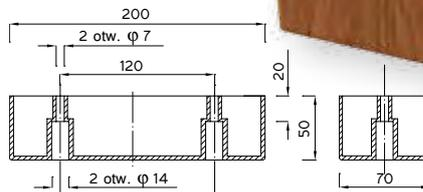
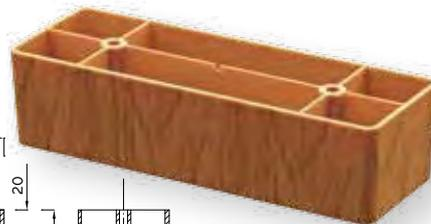

TW-M 1149

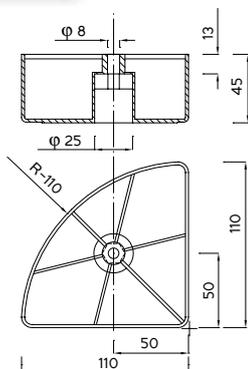

TW-M 1138.02

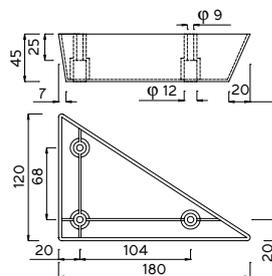

Noga prawa i lewa

TW-M 1207.01

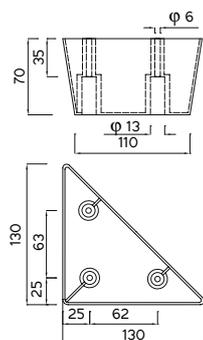

TW-M 1159.01

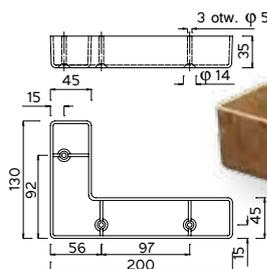

Noga prawa i lewa

TW-M 1205.01

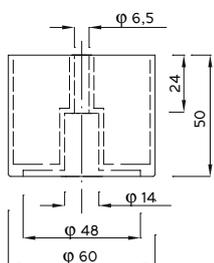

TW-M 1193.02

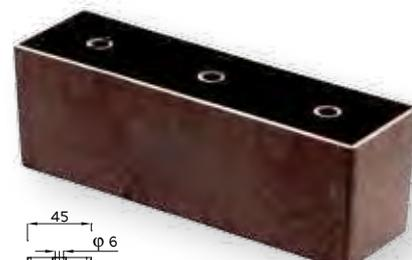
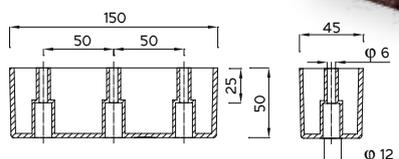



polysk

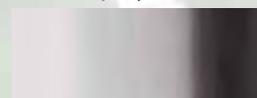

szczotka



toczony



Nogi aluminiowe
Kapsle aluminiowe pod klejenie UV
Nogi segmentowe
AL

Aluminium foots, aluminium caps, segments legs
Alufüße, Aluunterlagen für Glassplatten
Ножки алюминиевые, алюминиевые коплачки
для приклеивания, сегментные ножки



AL

AL-4001

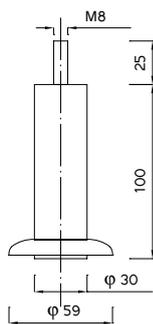

AL-4032

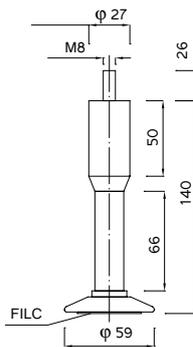

| Nr katalogowy | H |
|---------------|-----|
| AL-4002 | 100 |
| AL-4003 | 120 |

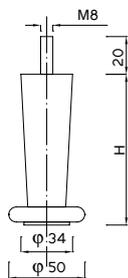

| Nr katalogowy | H |
|---------------|-----|
| AL-4015 | 120 |
| AL-4177 | 160 |

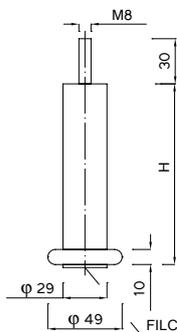

AL-4025

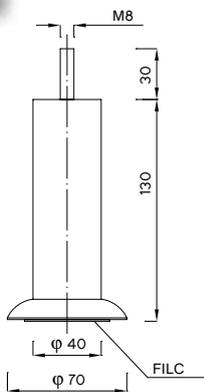

| Nr katalogowy | φ | φ1 | H |
|---------------|----|----|-----|
| AL-4013 | 90 | 60 | 100 |
| AL-4013.01 | 70 | 40 | 110 |
| AL-4198 | 70 | 32 | 145 |

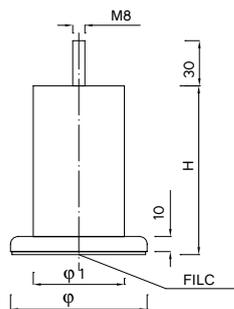

AL-4233

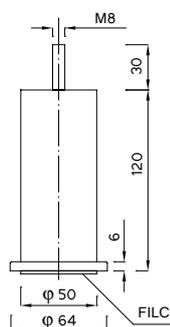

AL-4112

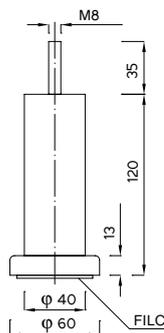



| Nr katalogowy | H |
|---------------|-----|
| AL-4017.01 | 100 |
| AL-4017 | 135 |
| AL-4018 | 150 |

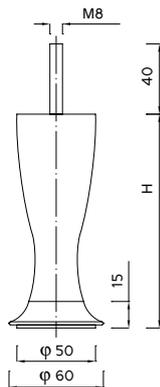

AL-4035

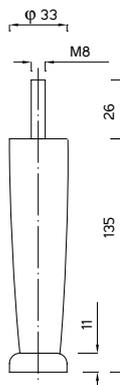

AL



AL-4019

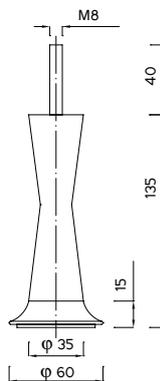

AL-4040

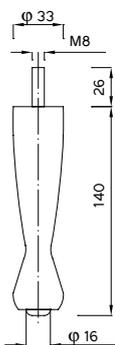

AL-4020

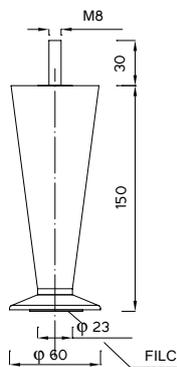

AL-4060

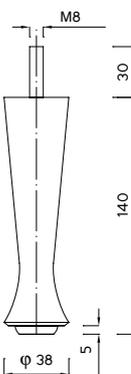

AL-4029

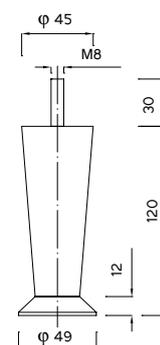

AL-4135

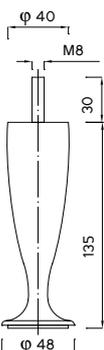



AL

AL-7456.01

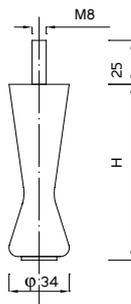
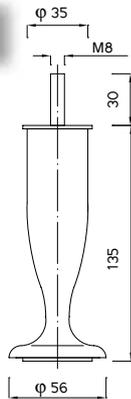

| Nr katalogowy | H |
|---------------|-----|
| AL-4004 | 80 |
| AL-4005 | 100 |
| AL-4006 | 120 |



AL-4185

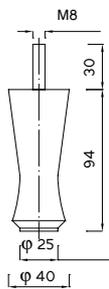
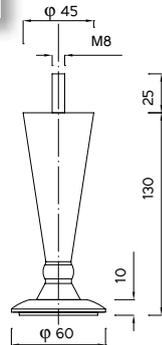

AL-4014



AL-4120

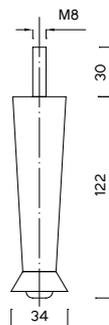
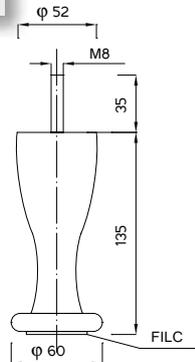

AL-4027



AL-4104

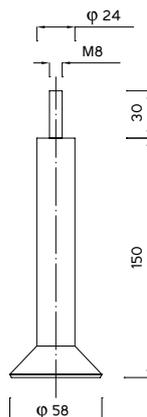
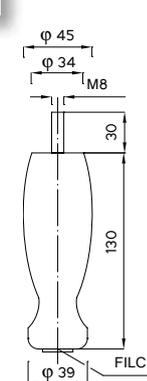

AL-4026



| Nr katalogowy | H | H1 |
|---------------|-----|-----|
| AL-4021 | 80 | 120 |
| AL-4022 | 100 | 140 |

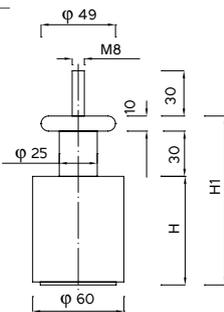

AL-4062

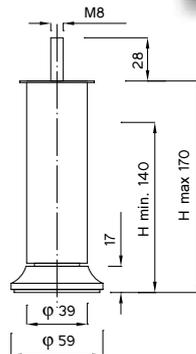

| Nr katalogowy | H |
|---------------|-----|
| AL-4166.07 | 60 |
| AL-4166.08 | 70 |
| AL-4166 | 80 |
| AL-4166.01 | 110 |
| AL-4166.09 | 120 |
| AL-4166.10 | 150 |
| AL-4166.06 | 160 |
| AL-4166.05 | 180 |

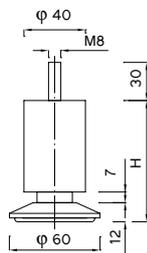

| Nr katalogowy | φ |
|---------------|----|
| AL-4126 | 40 |
| AL-4138 | 32 |

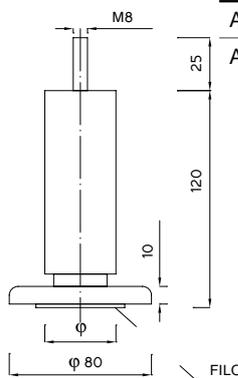

AL-4038

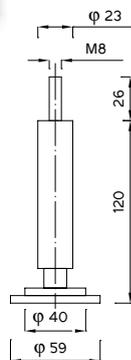

| Nr katalogowy | H |
|---------------|-----|
| AL-4012.04 | 50 |
| AL-4012.05 | 70 |
| AL-4012.03 | 80 |
| AL-4012 | 100 |
| AL-4046 | 105 |
| AL-4009 | 120 |
| AL-4045 | 130 |
| AL-4041 | 140 |
| AL-4010 | 150 |
| AL-4011 | 180 |

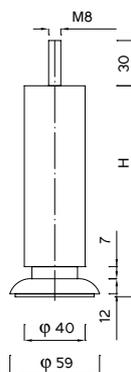

AL-4121

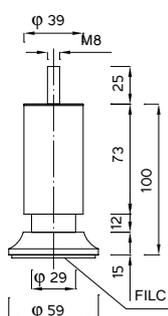

| Nr katalogowy | H |
|---------------|-----|
| AL-4127 | 120 |
| AL-4127.01 | 170 |

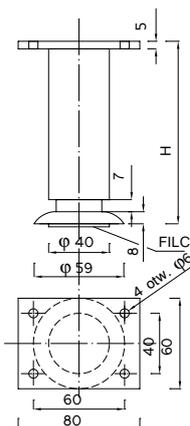



AL

AL-4123

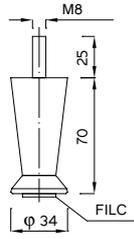

AL-4204

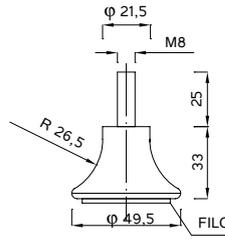

AL-4084

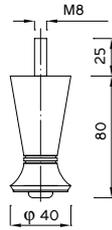

AL-4065

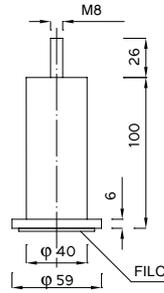

| Nr katalogowy | H |
|---------------|----|
| AL-7454.01 | 50 |
| AL-7454 | 80 |

AL-4008

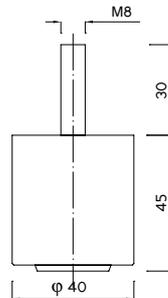
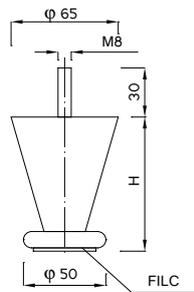

| Nr katalogowy | H |
|---------------|-----|
| AL-4215 | 80 |
| AL-4215.01 | 110 |

AL-4007

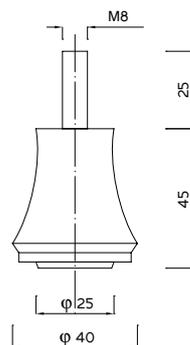
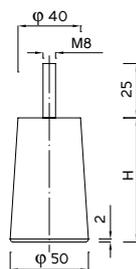



AL

| Nr katalogowy | H | L |
|---------------|-----|-----|
| AL-7293.01 | 120 | 80 |
| AL-7293.02 | 130 | 120 |
| AL-7293 | 135 | 80 |

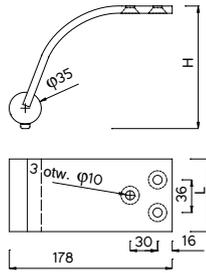

AL-7433

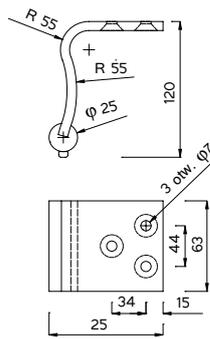

AL-7322

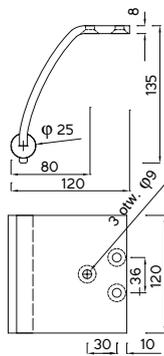

AL-7324

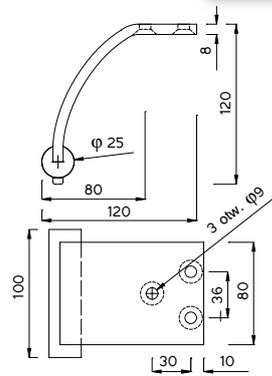

AL-7432

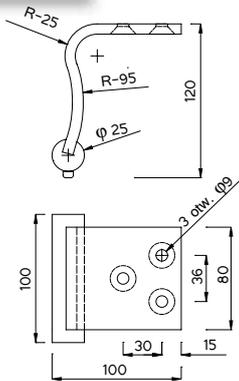

AL-7323

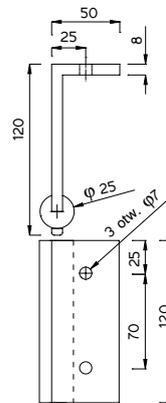

AL-7434

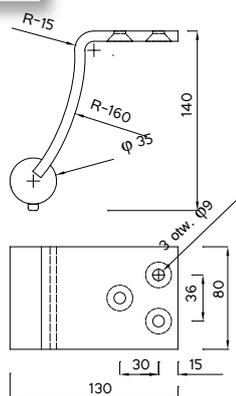

AL-7608

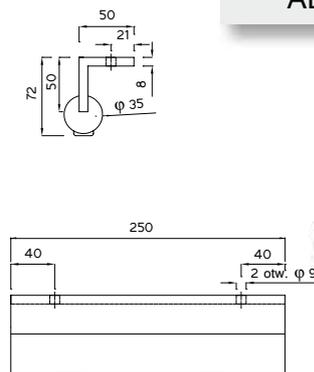



AL

AL-7437

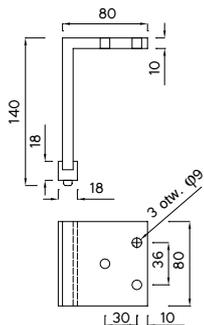

AL-7441

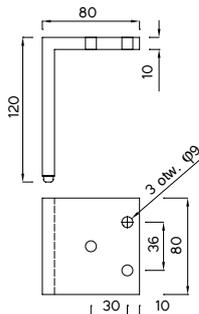

AL-7438

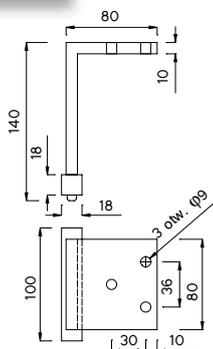

AL-7436

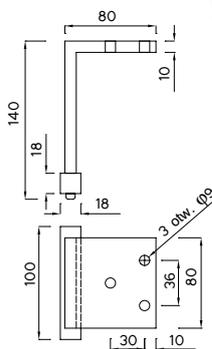

AL-7439

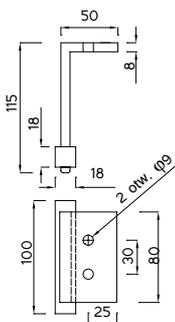

AL-7435

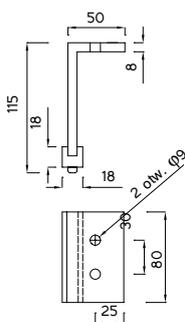

AL-7440

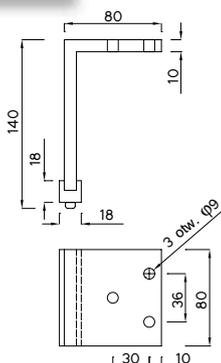

| Nr katalogowy | H | L | Nr katalogowy | H | L |
|---------------|----|-----|---------------|-----|-----|
| AL-4070 | 50 | 100 | AL-4164 | 80 | 300 |
| AL-4071 | 50 | 150 | AL-4069.01 | 90 | 246 |
| AL-4072 | 50 | 200 | AL-4066 | 100 | 100 |
| AL-4110 | 50 | 230 | AL-4067 | 100 | 150 |
| AL-4073 | 50 | 260 | AL-4068 | 100 | 200 |
| AL-4067.01 | 80 | 150 | AL-4069 | 100 | 260 |

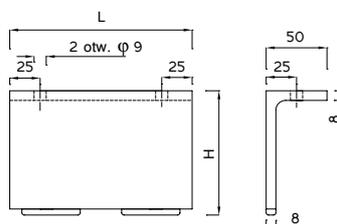



AL-7834

New

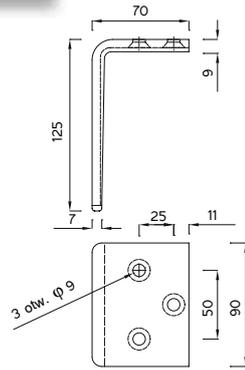

AL-7834.01

New

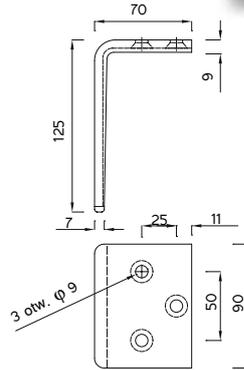

AL-7811.03

New

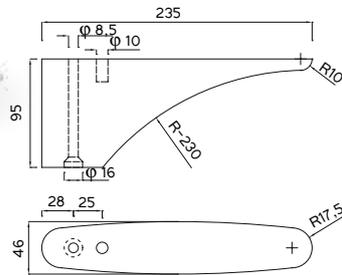

AL-4258

New

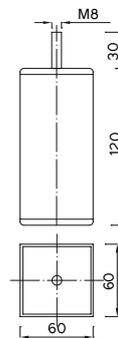

AL-7453.01

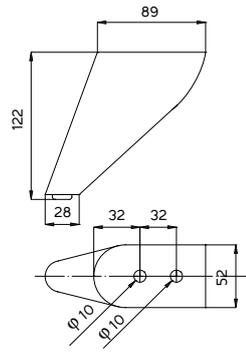

AL-7448

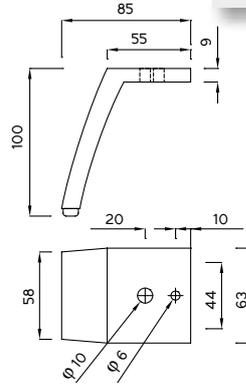

| Nr katalogowy | H |
|---------------|-----|
| AL-7455.01 | 80 |
| AL-7455 | 105 |

AL-7430

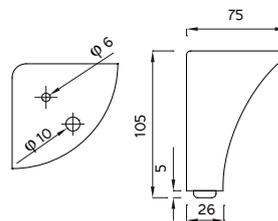
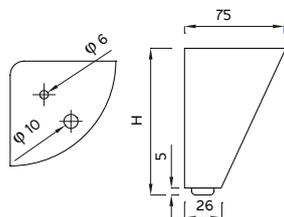



AL

AL-7609

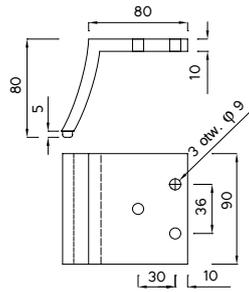

| Nr katalogowy | H |
|---------------|-----|
| AL-7449.04 | 130 |
| AL-7449.05 | 140 |
| AL-7449.06 | 150 |

| Nr katalogowy | H |
|---------------|-----|
| AL-7449 | 70 |
| AL-7449.01 | 100 |
| AL-7449.02 | 110 |
| AL-7449.03 | 120 |

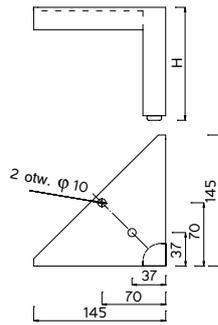

AL-7610

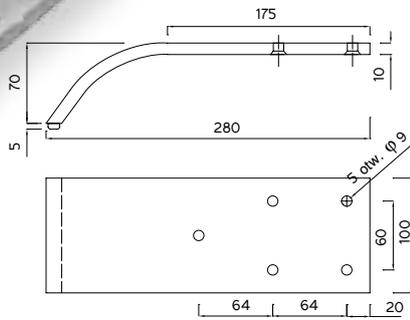
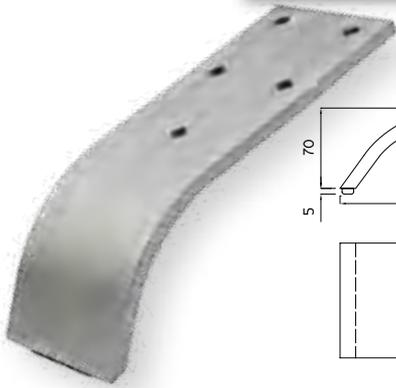

AL-7553

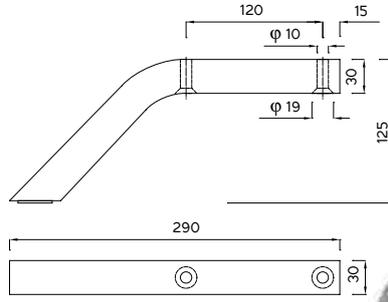
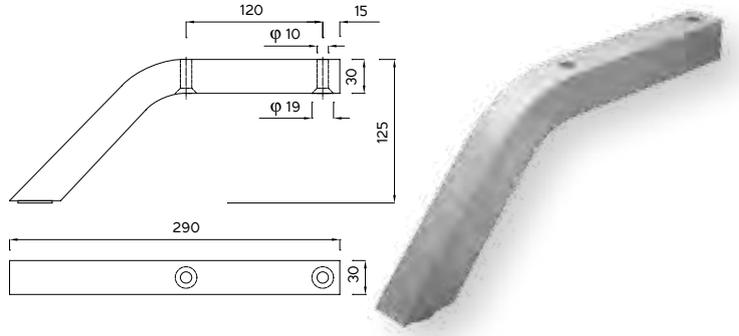

AL-7661

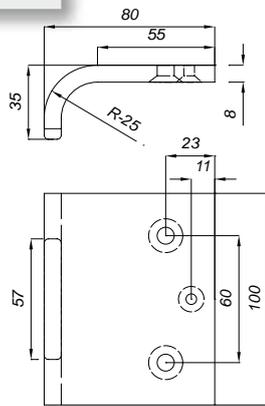

AL-7431

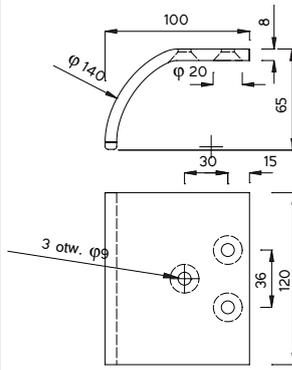
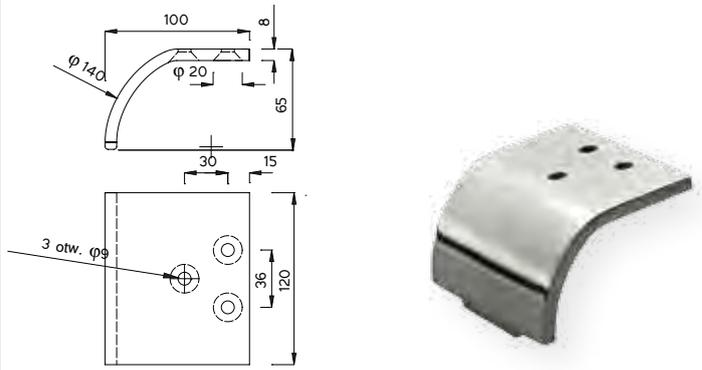

AL-7618

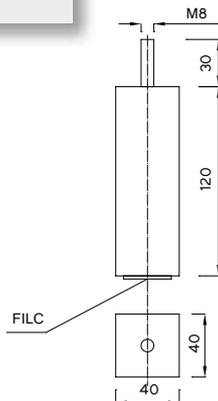

AL-4241

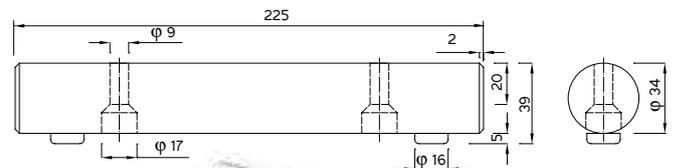
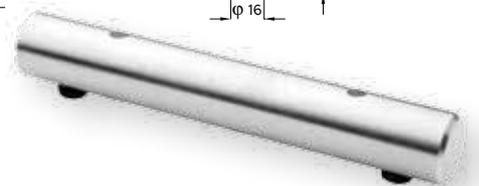



AL-4230

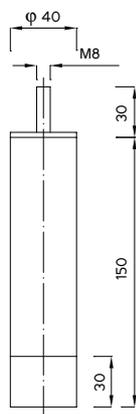

| Nr katalogowy | H | φ |
|---------------|-----|----|
| AL-4098.01 | 70 | 50 |
| AL-4077.01 | 70 | 60 |
| AL-4077 | 80 | 60 |
| AL-4098 | 90 | 50 |
| AL-4075 | 100 | 50 |
| AL-4093 | 120 | 60 |
| AL-4076 | 150 | 50 |

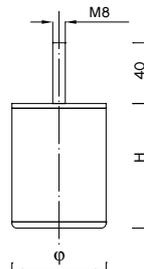

AL

AL-4210

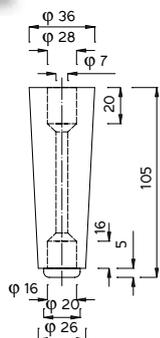

AL-4091

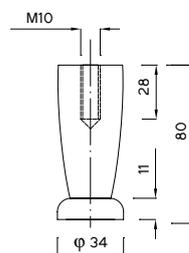

AL-7737.01

New

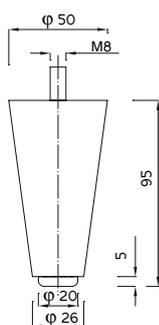

AL-7630.01

New

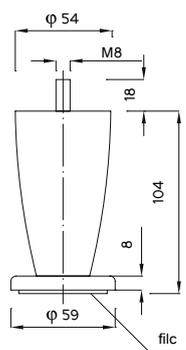

AL-4249

New

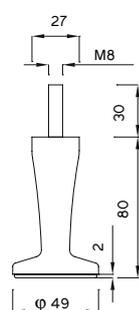

AL-7746.02

New

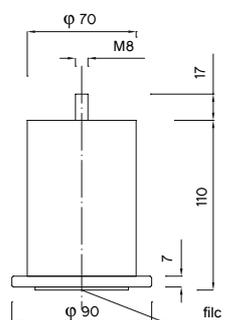



AL

AL-4080

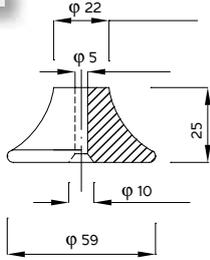

Nr katalogowy

H

AL-4024

33

AL-4024.01

40

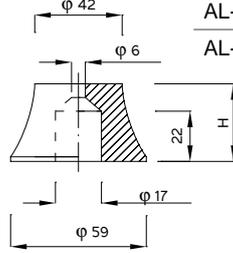

AL-4033

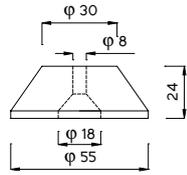

AL-4246

New

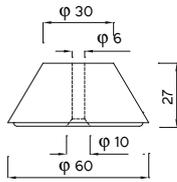

AL-4192

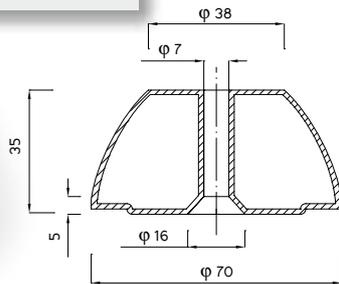

AL-4234.01

New

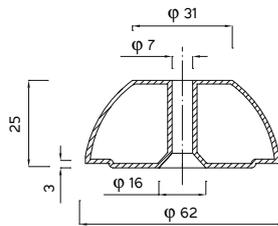

AL-4061

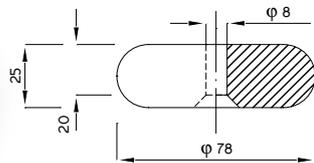

AL-4234

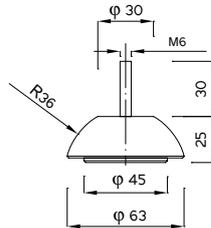

AL-4081.01

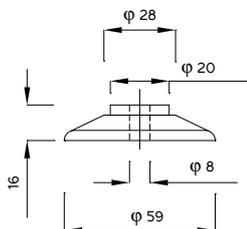

AL-4214

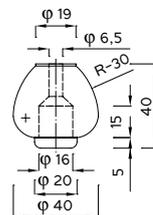

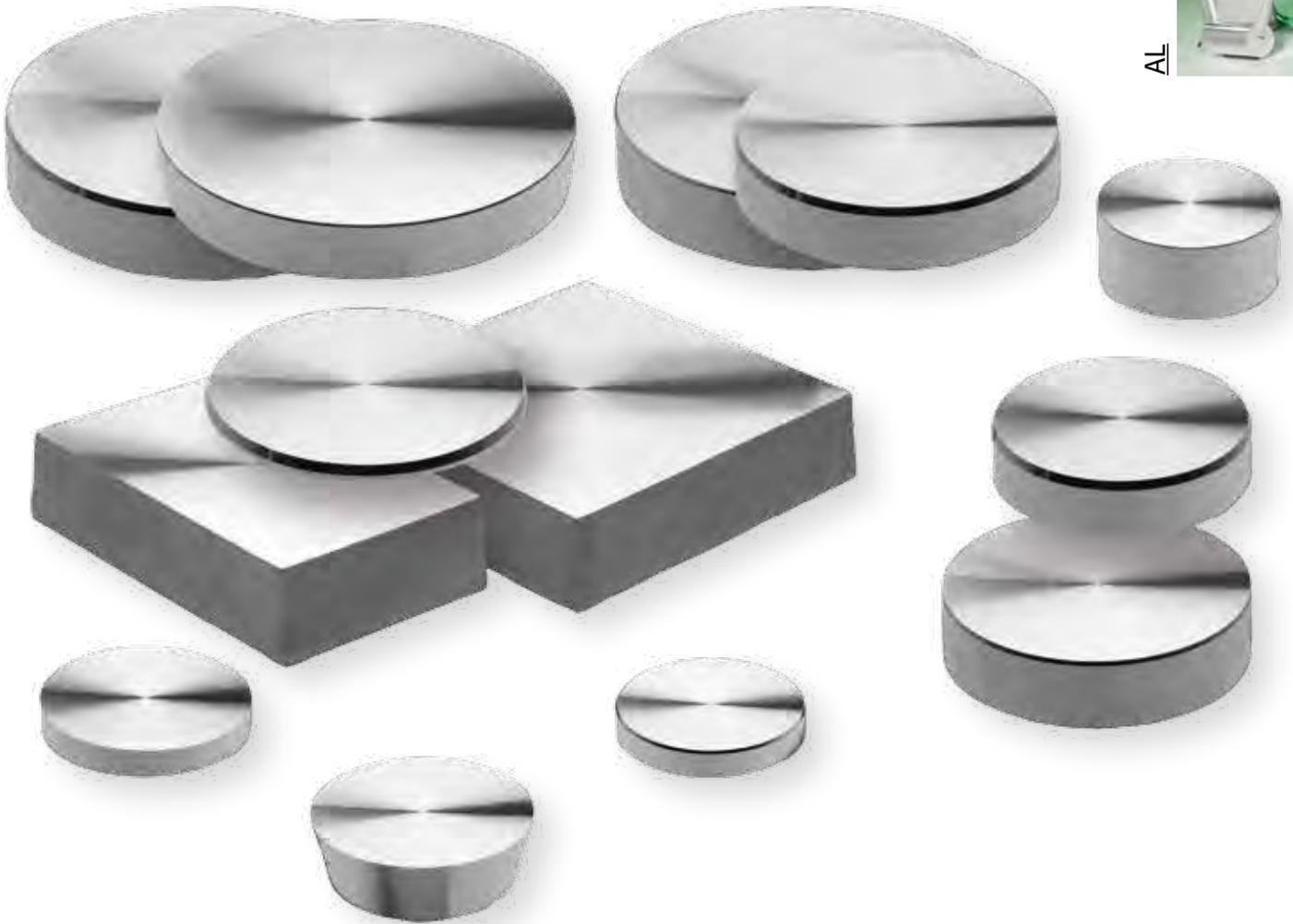

AL-4057

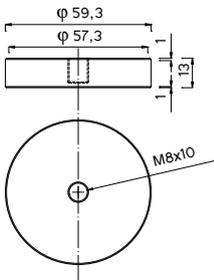

AL-4136

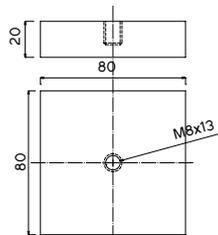

AL-4108

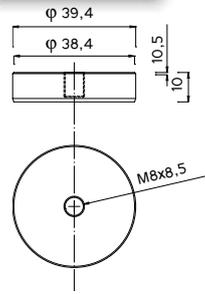

AL-4113

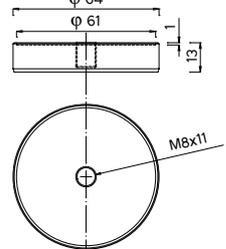

AL-4156

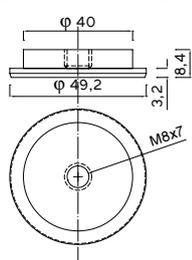

AL-4165

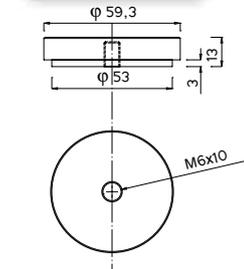

AL-4171

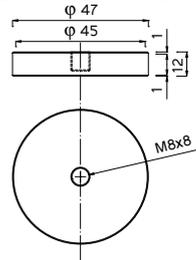

AL-4172

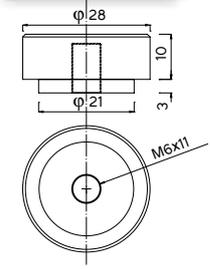

AL-4175

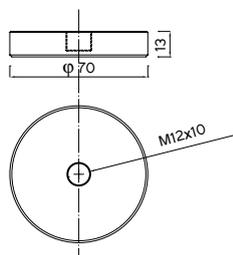

AL-4176

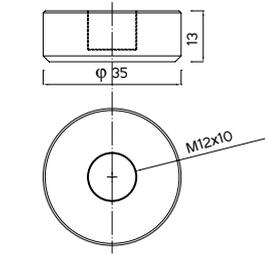

AL-4178.01

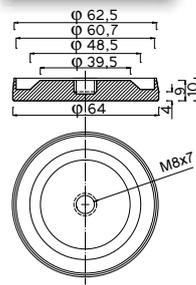

AL-4178

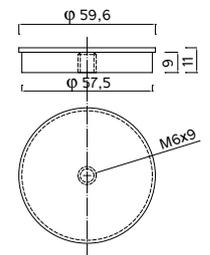



AL

Wysokość oraz skład danego segmentu Mogą być wykonane wg życzenia klienta. Pkt. 6 (opcja) można zastąpić zaślepką dolną z zatopioną nakrętką. Długość szpilki określa się indywidualnie. Dla potrzeb klienta.

The height and composition of a segment can be made according to the wishes of the customer. Item 6 (optionally) can be alternatively replaced with a bottom hole plug with a screw-on top. The length of the needle is individually chosen according to the needs of the customer.

Die Höhe und Zusammensetzung eines Segmentes können entsprechend dem Wunsch des Kunden ausgeführt sein. Der Punkt 6 (wahlweise) läßt einen unteren Blindflansch mit Schraubenmutter ersatzweise zu. Die Länge der Nadel wird individuell nach den Bedürfnissen des Kunden bestimmt.

Высота и состав данного сегмента. Они могут быть изготовлены по желанию клиента. П. 6 (опция) можно заменить нижней заглушкой с затопленной гайкой. Длину шпильки определяется индивидуально по нуждам клиента.

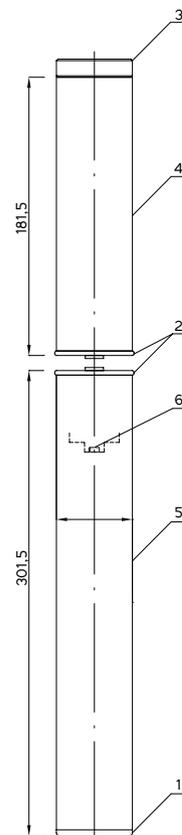

ST-3068.01



ST-3068

| Nr części | Ilość | Nazwa części |
|-----------|-------|--------------------------------------|
| 1 | 1 | zaślepka \varnothing 50 |
| 2 | 2 | przekładka pod rurę \varnothing 50 |
| 3 | 1 | AL-4057.01 |
| 4 | 1 | rura \varnothing 50 L-180 |
| 5 | 1 | rura \varnothing 50 L-295 |
| 6 | 1 | bednarka z nakrętką (opcja) |





buk



wiśnia



czarny

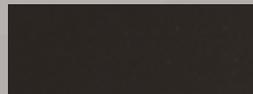

Nogi drewniane DR

Wooden legs
Möbelholzfüße
Деревянные ножки



DR

| Nr katalogowy | H | H1 |
|---------------|-----|----|
| DR-5001.01 | 100 | 25 |
| DR-5001.02 | 120 | 30 |
| DR-5001 | 135 | 25 |

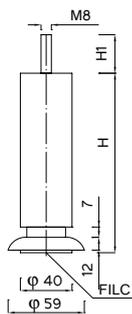

| Nr katalogowy | H |
|---------------|-----|
| DR-5002.03 | 100 |
| DR-5002 | 130 |

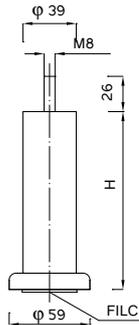

DR-5005

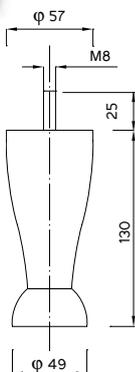

| Nr katalogowy | H |
|---------------|-----|
| DR-5003.02 | 120 |
| DR-5003 | 130 |

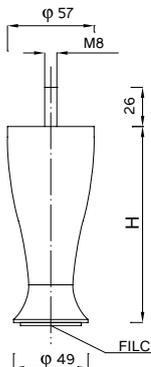

DR-5004

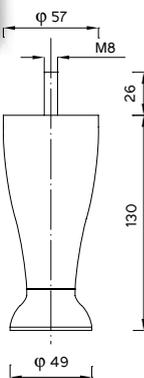

DR-5015

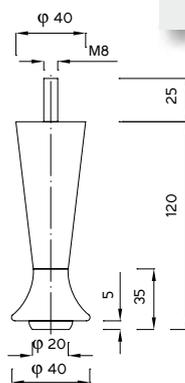

DR-5047

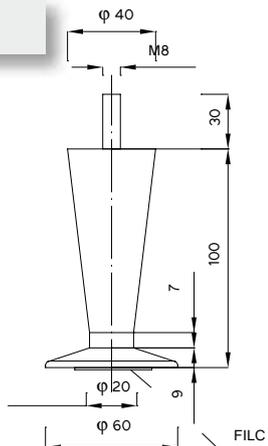

DR-5048

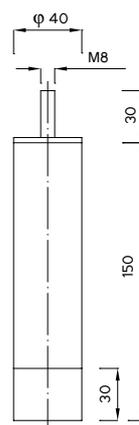

DR-5010

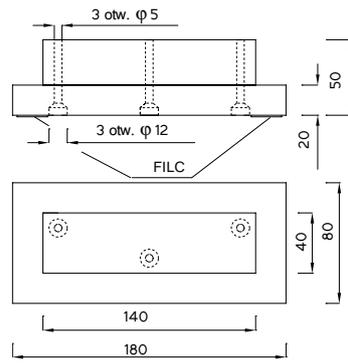

DR-5016

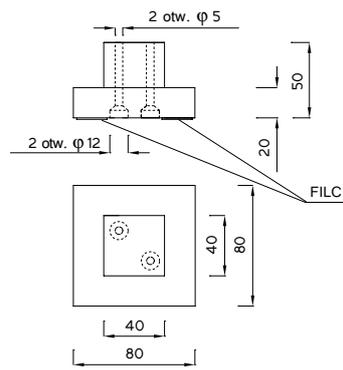

DR-7539



Noga prawa i lewa

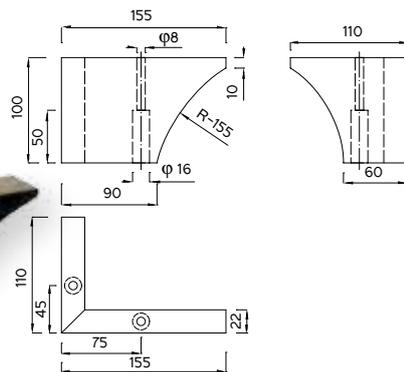

DR-5046

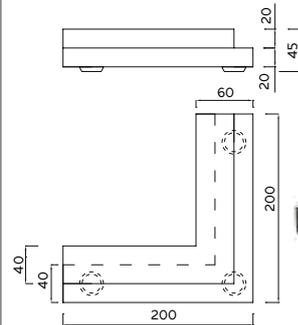

DR-7612

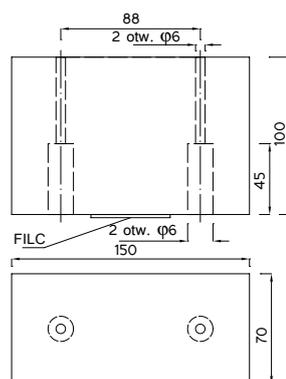

DR-7611

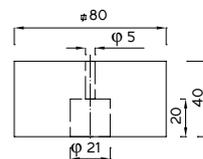

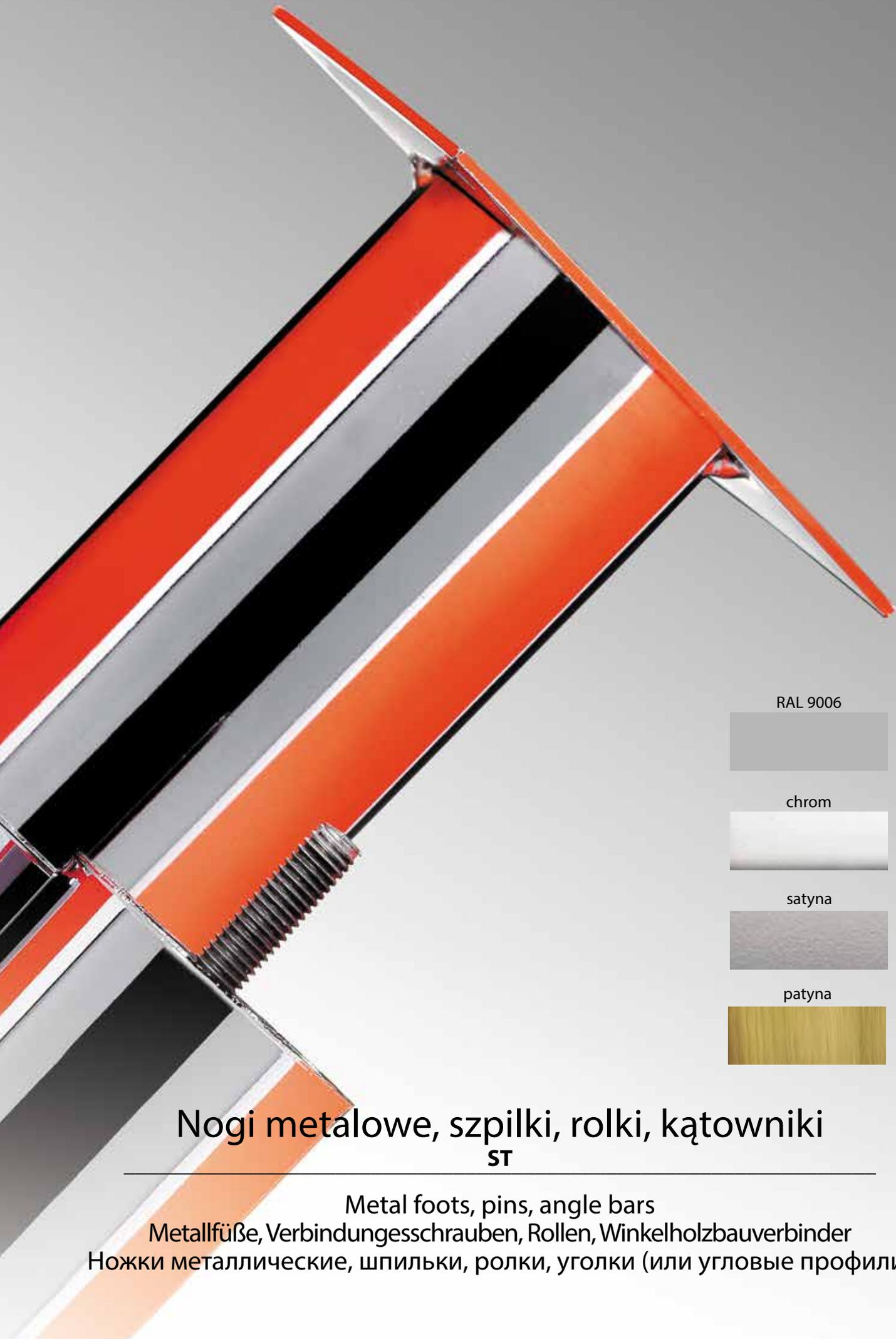

RAL 9006

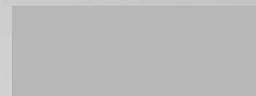

chrom



satyna



patyna



Nogi metalowe, szpilki, rolki, kątowniki ST

Metal foots, pins, angle bars

Metallfüße, Verbindungsschrauben, Rollen, Winkelholzbauverbinder

Ножки металлические, шпильки, rolki, уголки (или угловые профили)



| Nr katalogowy | H |
|---------------|-----|
| ST-3226 | 100 |
| ST-3017 | 120 |
| ST-3018 | 130 |
| ST-3018.02 | 180 |
| ST-3018.01 | 200 |

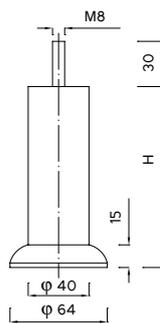
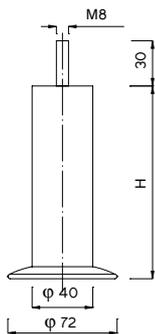

| Nr katalogowy | H |
|---------------|-----|
| ST-3011.01 | 100 |
| ST-3011 | 120 |



| Nr katalogowy | H |
|---------------|----|
| ST-3163 | 25 |
| ST-3164 | 35 |

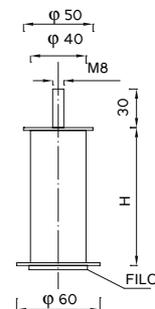
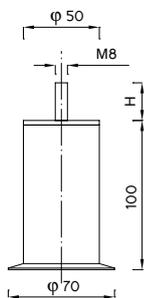

| Nr katalogowy | H |
|---------------|-----|
| ST-3131 | 100 |
| ST-3134 | 140 |



ST-3015

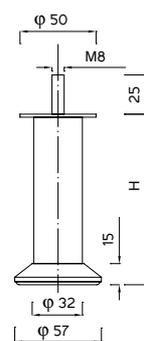
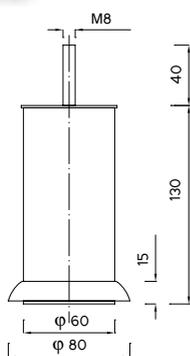

| Nr katalogowy | H |
|---------------|-----|
| ST-3097 | 110 |
| ST-3329 | 120 |



ST-3418

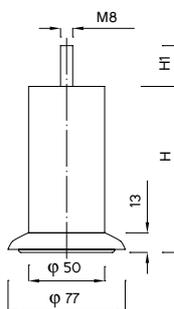
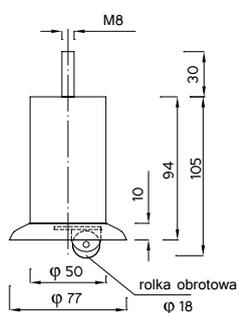

| Nr katalogowy | H | H1 |
|---------------|-----|----|
| ST-3188.04 | 70 | 30 |
| ST-3351 | 90 | 20 |
| ST-3188.02 | 100 | 30 |
| ST-3188 | 110 | 30 |
| ST-3188.01 | 120 | 30 |
| ST-3188.03 | 130 | 30 |





IS

ST-3212

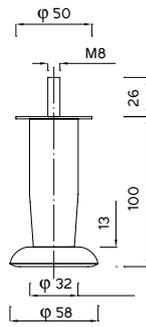

| Nr katalogowy | H |
|---------------|-----|
| ST-3214 | 100 |
| ST-3215 | 120 |
| ST-3216 | 150 |

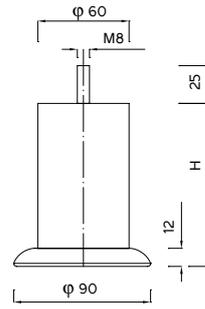

ST-3205

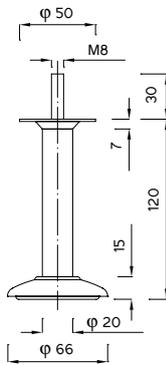

| Nr katalogowy | H |
|---------------|-----|
| ST-3220 | 50 |
| ST-3089 | 100 |
| ST-3083 | 105 |
| ST-3093 | 120 |
| ST-3142 | 130 |
| ST-3094 | 140 |

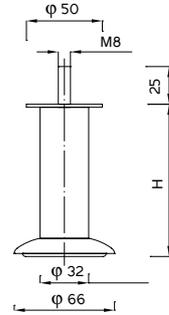

ST-3452

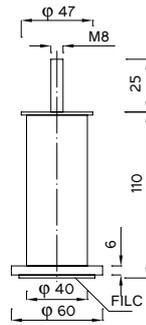

ST-3341

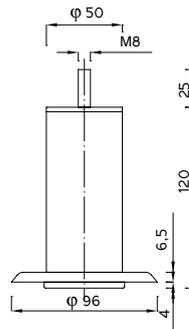

ST-3503

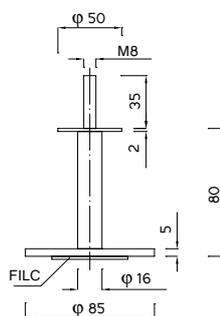

ST-3429

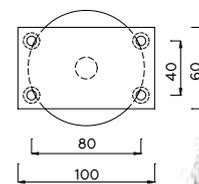
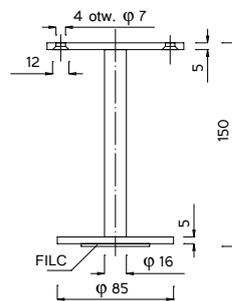

| Nr katalogowy | H |
|---------------|-----|
| ST-3084 | 90 |
| ST-3102 | 100 |
| ST-3103 | 120 |



ST-7172

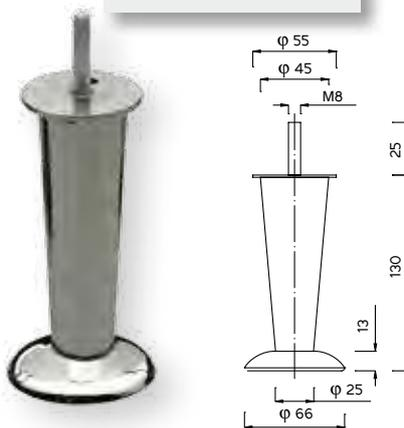

| Nr katalogowy | H |
|---------------|----|
| ST-3052.01 | 80 |
| ST-3052 | 90 |

ST

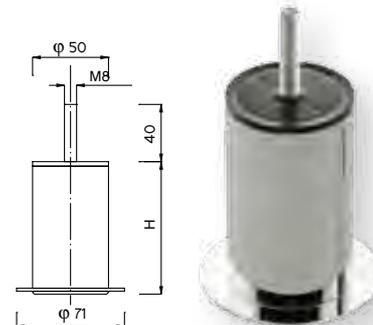

ST-3058



ST-3057

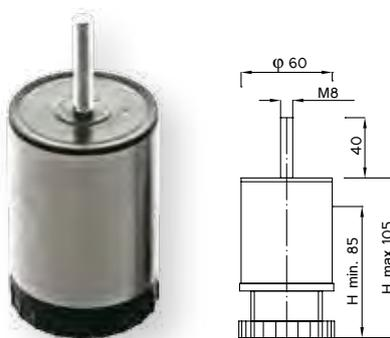

| Nr katalogowy | φ | H |
|---------------|----|-----|
| ST-3013 | 50 | 80 |
| ST-3014 | 50 | 150 |

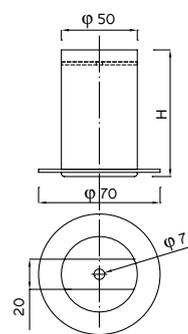

| Nr katalogowy | H | H1 | φ |
|---------------|-----|----|----|
| ST-3049 | 40 | 40 | 60 |
| ST-3029 | 55 | 25 | 50 |
| ST-3030 | 70 | 25 | 50 |
| ST-3031 | 90 | 25 | 50 |
| ST-3088 | 100 | 40 | 60 |
| ST-3044 | 110 | 25 | 60 |
| ST-3032 | 110 | 40 | 50 |
| ST-3033 | 120 | 40 | 50 |
| ST-3045 | 120 | 40 | 60 |
| ST-3034 | 130 | 40 | 50 |

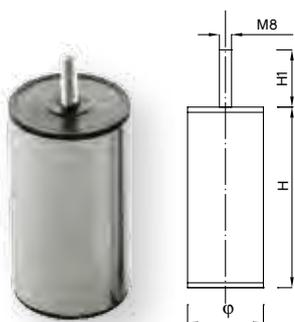

| Nr katalogowy | H | H1 | φ |
|---------------|-----|----|----|
| ST-3051 | 130 | 40 | 60 |
| ST-3035 | 140 | 40 | 50 |
| ST-3046 | 140 | 40 | 60 |
| ST-3105 | 150 | 40 | 50 |
| ST-3047 | 150 | 25 | 60 |
| ST-3050 | 150 | 40 | 60 |
| ST-3048 | 160 | 40 | 60 |
| ST-3029.01 | 200 | 25 | 50 |
| ST-3035.01 | 250 | 40 | 50 |

ST-3539

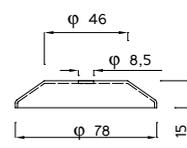

| Nr katalogowy | H | H1 | φ |
|---------------|----|----|----|
| ST-3025.01 | 30 | 25 | 50 |
| ST-3037.01 | 40 | 40 | 60 |
| ST-3036 | 60 | 40 | 60 |
| ST-3471.01 | 50 | 35 | 80 |
| ST-3255 | 60 | 25 | 70 |
| ST-3063 | 60 | 40 | 80 |
| ST-3486 | 70 | 30 | 70 |
| ST-3114 | 70 | 40 | 60 |
| ST-3195 | 80 | 25 | 70 |
| ST-3471 | 80 | 35 | 80 |
| ST-3056.01 | 80 | 40 | 50 |

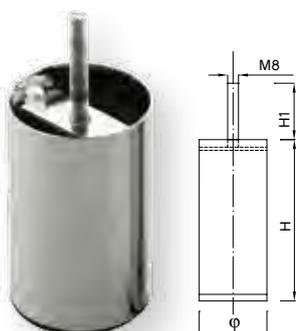

| Nr katalogowy | H | H1 | φ |
|---------------|-----|----|----|
| ST-3037 | 80 | 40 | 60 |
| ST-3025.02 | 90 | 25 | 50 |
| ST-3414 | 90 | 40 | 32 |
| ST-3320.03 | 90 | 40 | 40 |
| ST-3025 | 90 | 40 | 50 |
| ST-3320.02 | 100 | 25 | 40 |
| ST-3026 | 100 | 25 | 50 |
| ST-3038 | 100 | 25 | 60 |
| ST-3026.01 | 100 | 30 | 50 |
| ST-3486.01 | 100 | 30 | 70 |
| ST-3039 | 100 | 40 | 60 |
| ST-3340 | 120 | 25 | 80 |
| ST-3040 | 120 | 25 | 60 |

| Nr katalogowy | H | H1 | φ |
|---------------|-----|-----|----|
| ST-3027 | 120 | 25 | 50 |
| ST-3041 | 120 | 40 | 60 |
| ST-3143 | 130 | 40 | 60 |
| ST-3137.01 | 140 | 25 | 40 |
| ST-3028.01 | 150 | 25 | 50 |
| ST-3028 | 150 | 40 | 50 |
| ST-3042 | 160 | 40 | 60 |
| ST-3055 | 165 | 110 | 50 |
| ST-3484 | 180 | 30 | 40 |
| ST-3043 | 180 | 40 | 60 |
| ST-3168 | 200 | 40 | 60 |
| ST-3151 | 200 | 50 | 40 |
| ST-3340.01 | 220 | 25 | 80 |



IS

| Nr katalogowy | H |
|---------------|-----|
| ST-3010.03 | 35 |
| ■ ST-3153.03 | 60 |
| ST-3153 | 100 |
| ST-3010.05 | 110 |
| ST-3010 | 130 |

| Nr katalogowy | H |
|---------------|-----|
| ST-3154 | 150 |
| ST-3217 | 180 |
| ST-3010.01 | 200 |

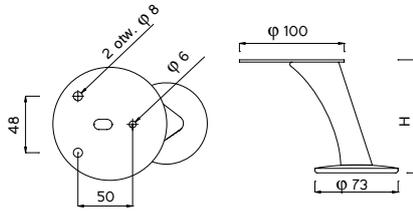

ST-3053

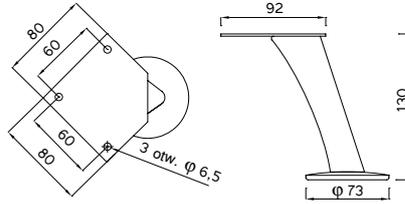

ST-3510

| Nr katalogowy | H |
|---------------|-----|
| ST-3218 | 100 |
| ST-3311 | 120 |
| ST-3219 | 130 |
| ST-3295.01 | 150 |

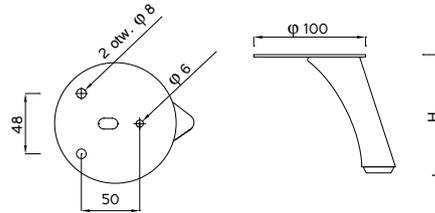
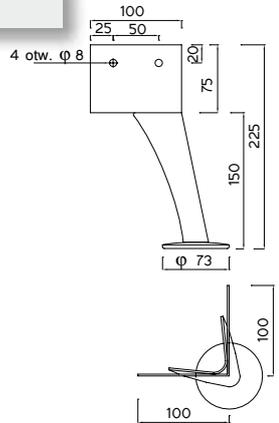

ST-3095

ST-3001

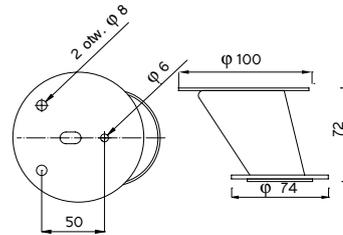
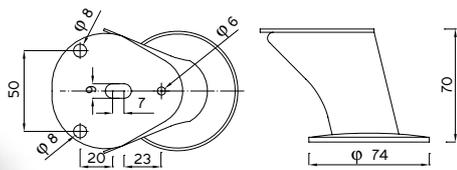

| Nr katalogowy | H |
|---------------|-----|
| ST-3012 | 125 |
| ST-3152 | 160 |
| ST-3152.01 | 200 |

ST-3167

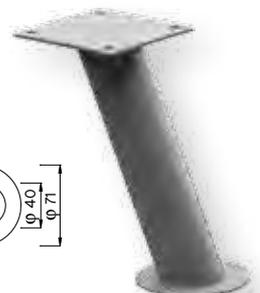
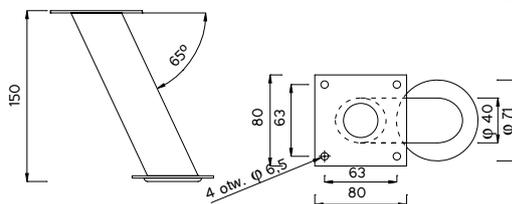
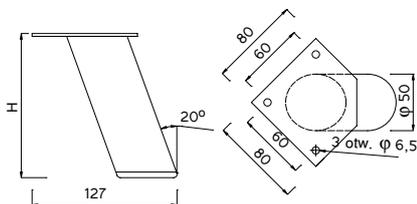

ST-3021

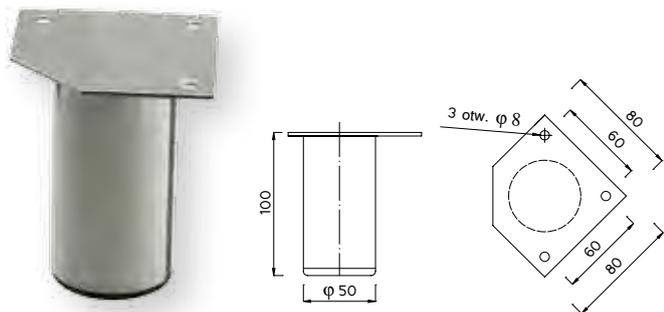

ST-3161

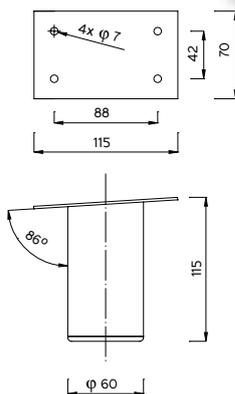

ST

| Nr katalogowy | H | H1 | φ |
|---------------|-----|----|----|
| ST-3121 | 60 | 25 | 50 |
| ST-3120 | 75 | 25 | 50 |
| ST-3120.01 | 100 | 25 | 50 |
| ST-3415 | 105 | 35 | 40 |
| ST-3121.01 | 120 | 25 | 50 |

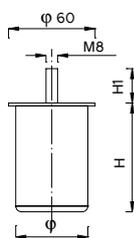

| Nr katalogowy | H |
|---------------|-----|
| ■ ST-7712 | 100 |
| ■ ST-7712.01 | 120 |

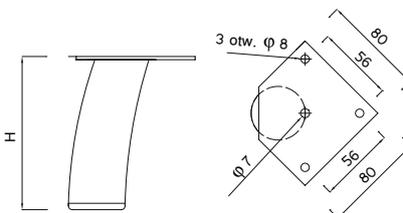

| Nr katalogowy | H |
|---------------|-----|
| ST-3091 | 125 |
| ST-3138 | 180 |

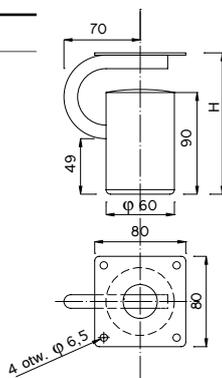

ST-3424

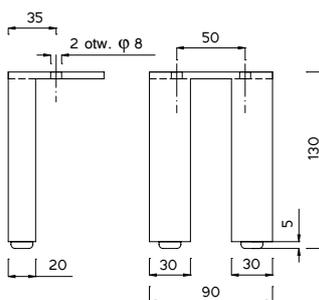

ST-3466

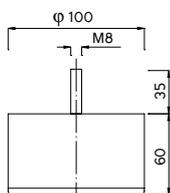

ST-3056

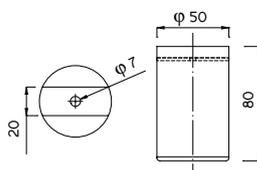



IS

ST-3009.01

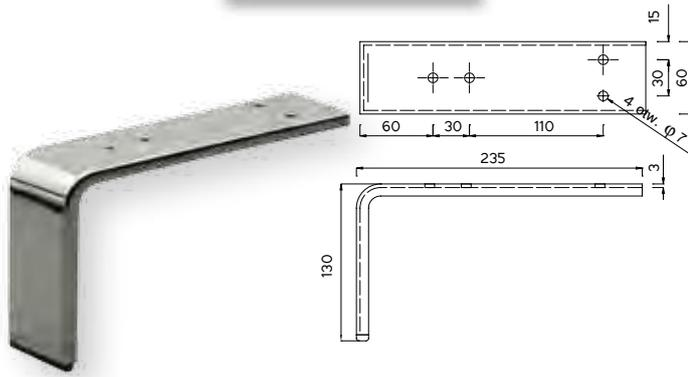

ST-3009.03

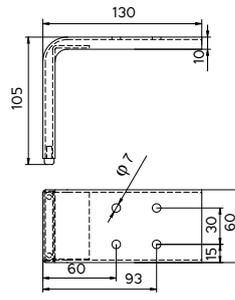

ST-3501

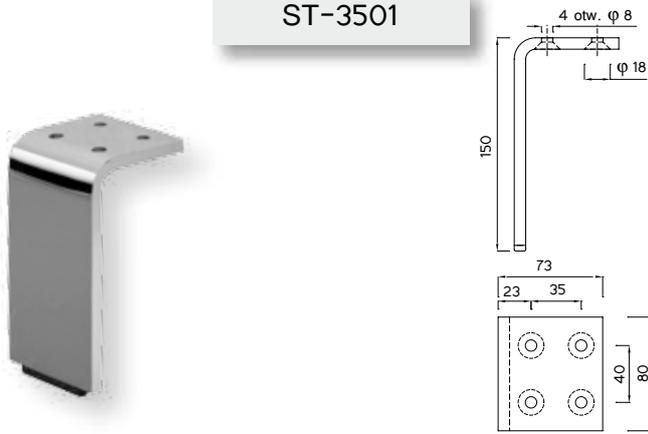

ST-3576

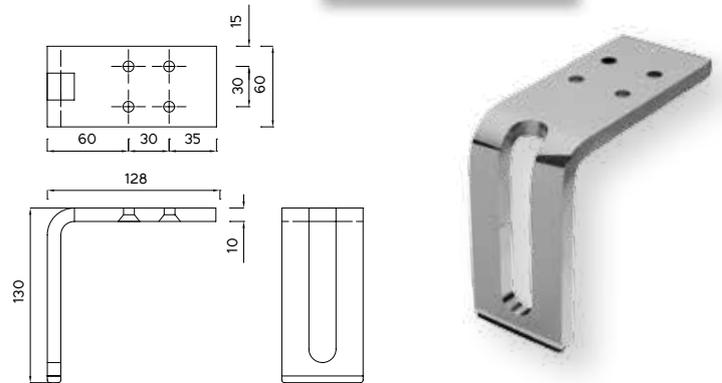

ST-3016

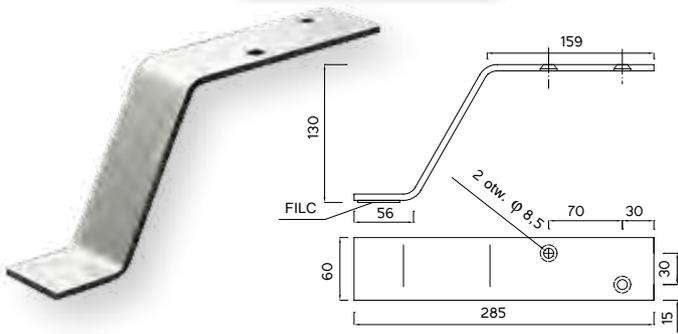

ST-3403

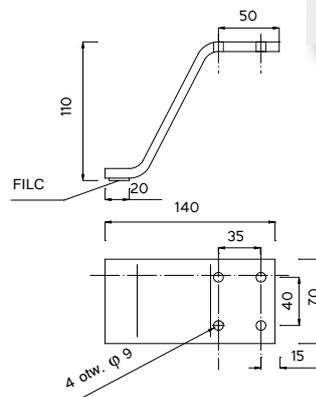

ST-7633

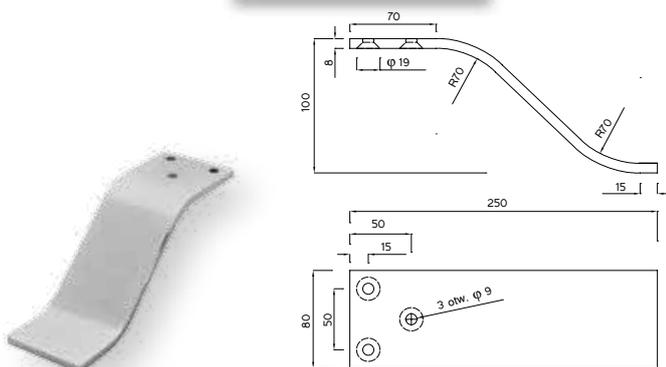

ST-7280

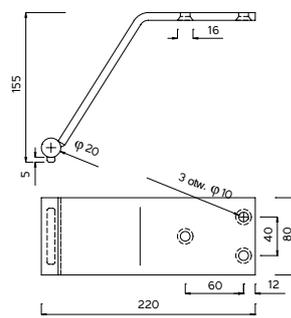

ST-3674.02

New

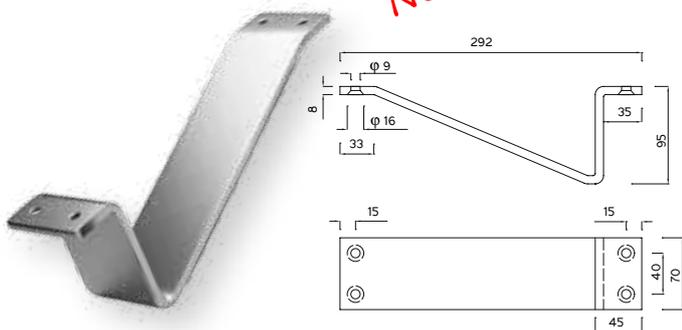

ST-3674.021

New

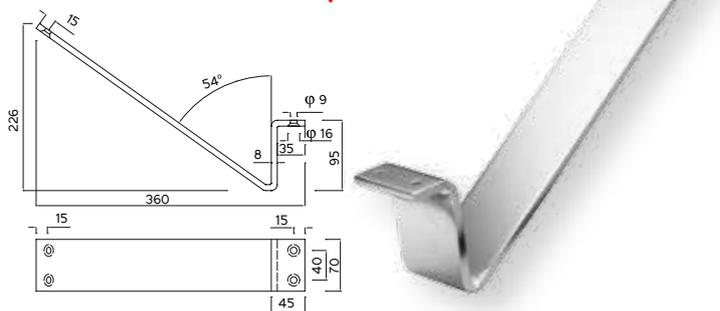

ST

ST-3717

New

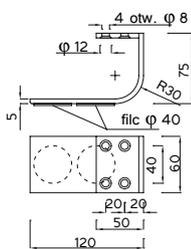

ST-3717.01

New

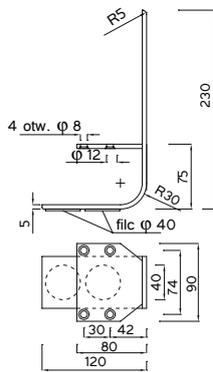

ST-7713

New

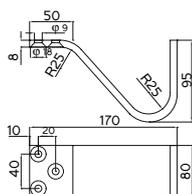

ST-3692.01

New



Noga prawa i lewa

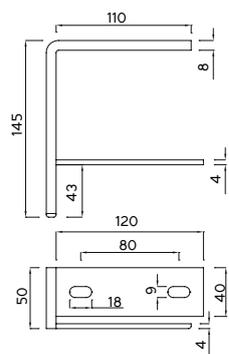

ST-3705

New

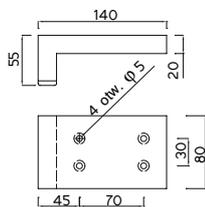

ST-3502.011

New

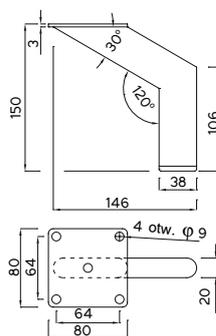



IS

ST-7524

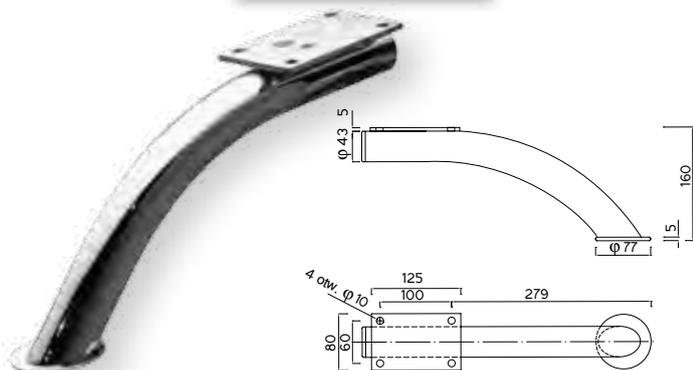

ST-3483

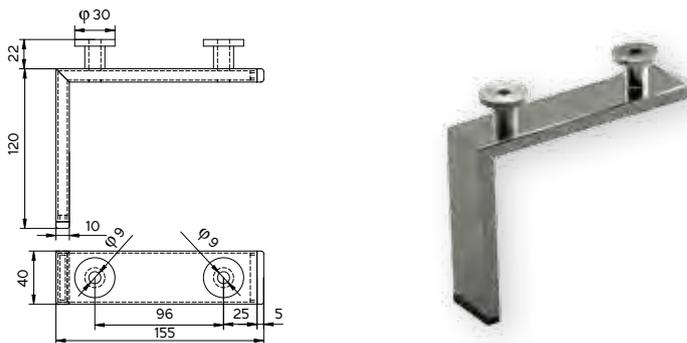

ST-3421

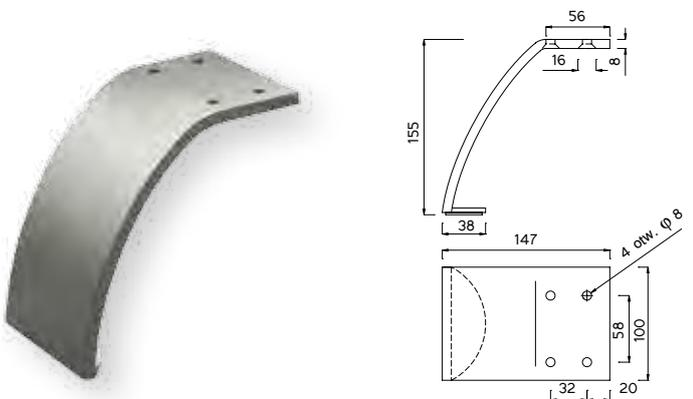

ST-3571

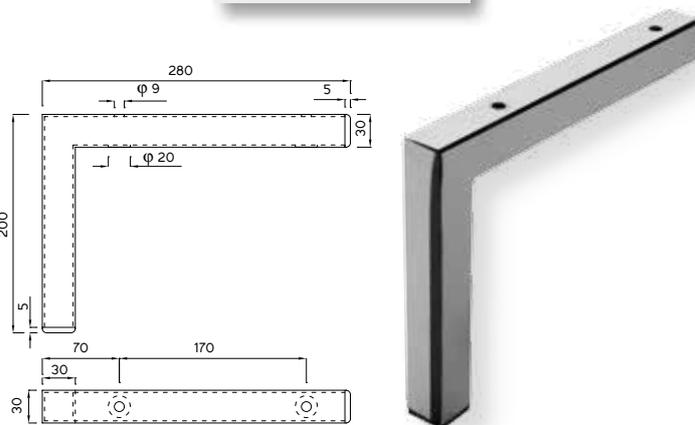

ST-3633

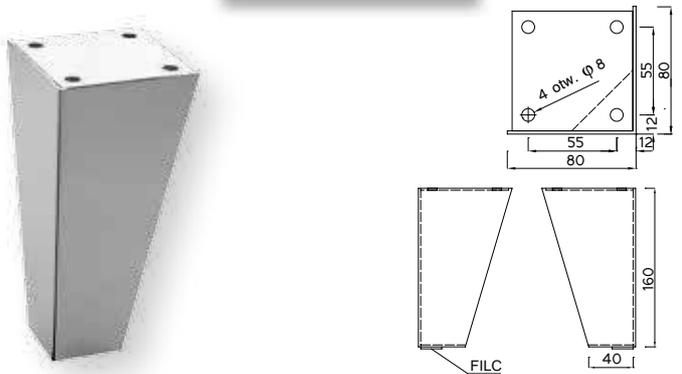

ST-3582

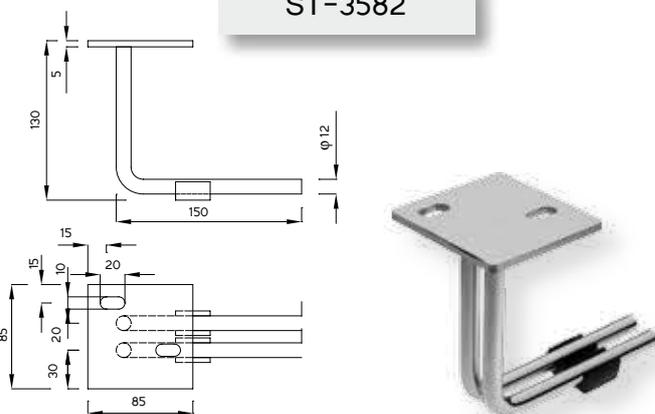

ST-3575

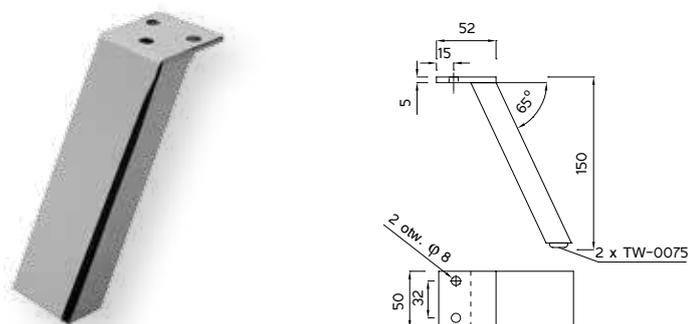

ST-3610

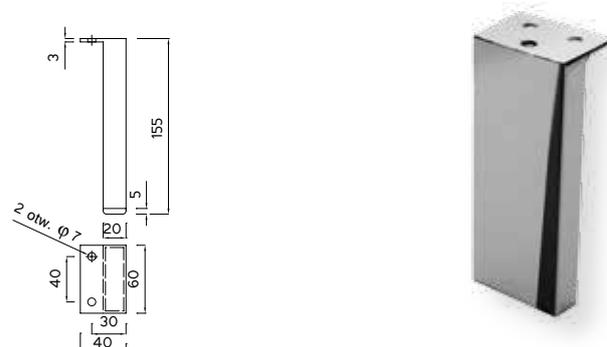

ST-3422

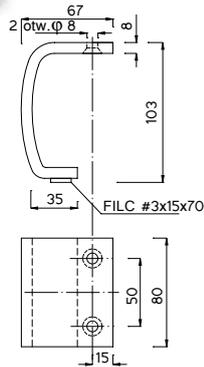

ST-3408

ST

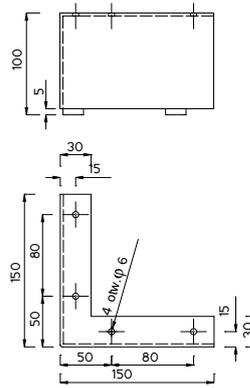

ST-3165

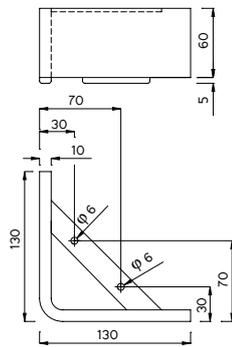

ST-3165.07

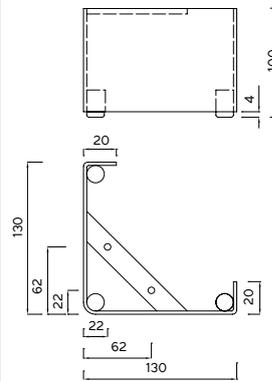

| Nr katalogowy | H |
|---------------|-----|
| ST-3401.01 | 80 |
| ST-3401.02 | 120 |
| ST-3401 | 130 |
| ST-3401.03 | 160 |

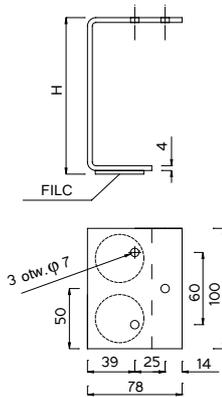

ST-3505

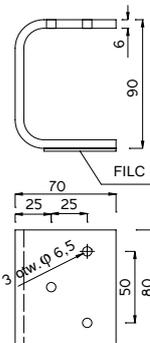

ST-3634

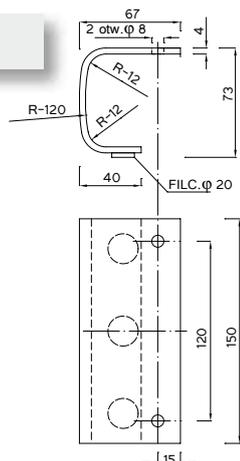

ST-7607

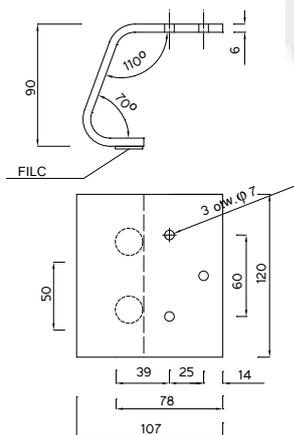



IS

ST-7457

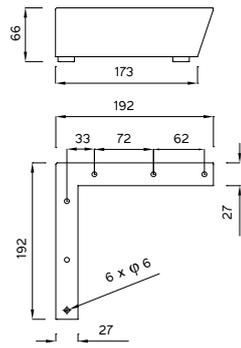

ST-7318

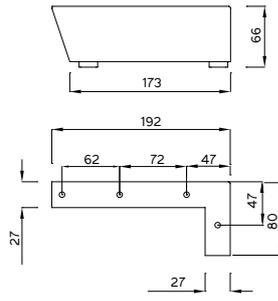

Noga prawa i lewa

ST-3417



Noga prawa i lewa

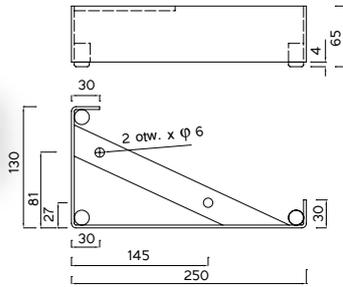

ST-3336



Noga prawa i lewa

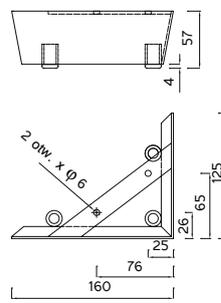

ST-3358.01

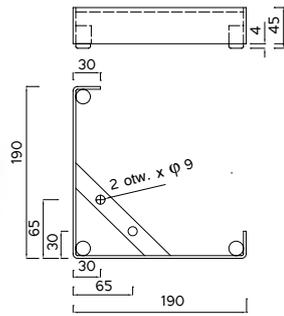

ST-3358

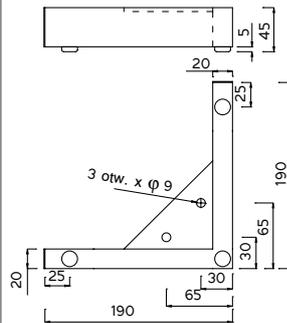

ST-3529.01

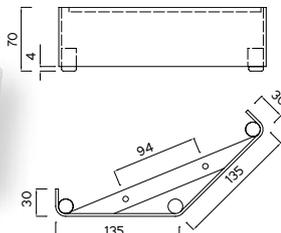

ST-3529

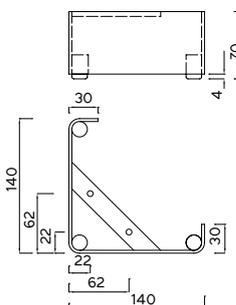

ST-3304

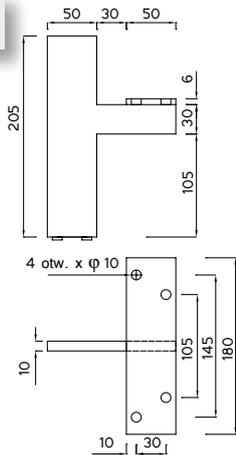

ST-3305

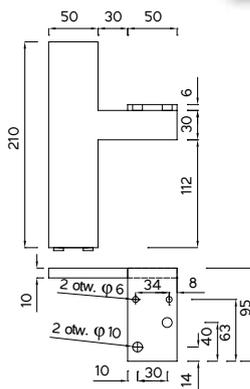

ST

ST-3457

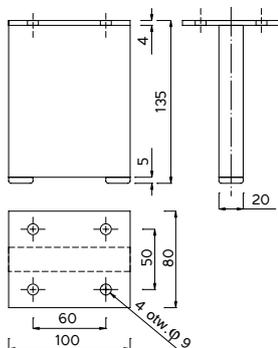

ST-3518

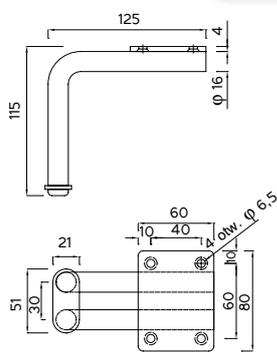

| Nr katalogowy | φ | H | H1 |
|---------------|----|-----|----|
| ST-3409 | 40 | 80 | 30 |
| ST-3073 | 40 | 100 | 40 |
| ST-3213 | 60 | 100 | 40 |
| ST-3398 | 60 | 150 | 40 |

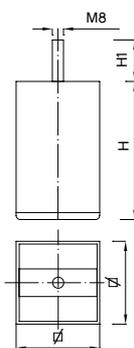

ST-7443

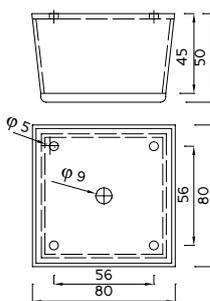

ST-3536

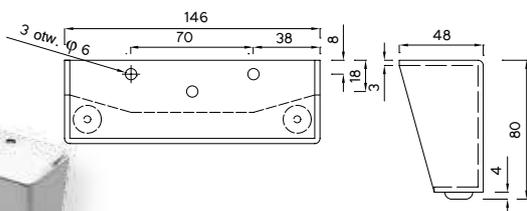

ST-7288

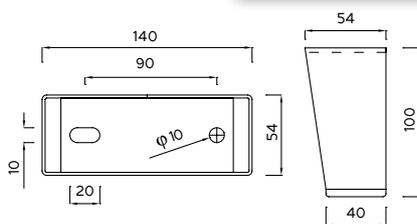



IS

| Nr katalogowy | H | L |
|---------------|-----|-----|
| ST-3201 | 80 | 140 |
| ST-3201.01 | 80 | 150 |
| ST-3291 | 100 | 140 |
| ST-3284 | 120 | 140 |
| ST-3201.03 | 150 | 150 |
| ST-3284.01 | 160 | 140 |

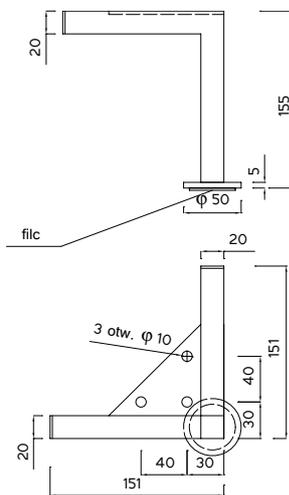
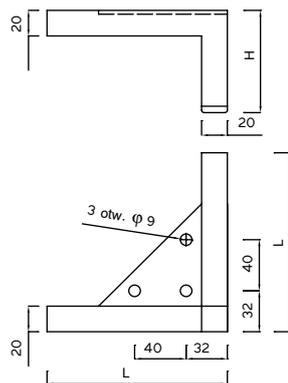

ST-3570



| Nr katalogowy | H |
|---------------|-----|
| ST-3113.01 | 100 |
| ST-3113.02 | 110 |
| ST-3113 | 120 |

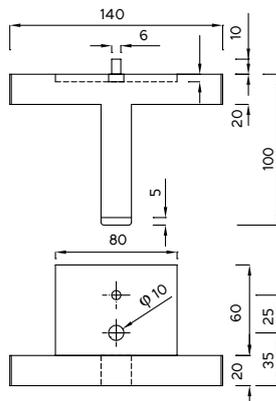
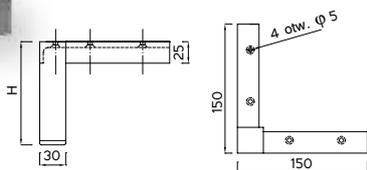

ST-3464



ST-3514

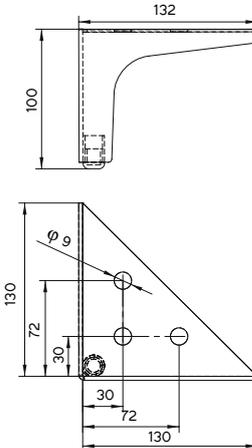
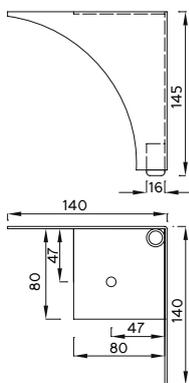

ST-3319



| Nr katalogowy | H | Nr katalogowy | H |
|---------------|-----|---------------|-----|
| ST-3382 | 60 | ST-3396 | 140 |
| ST-3233 | 80 | ST-3224 | 150 |
| ST-3232 | 100 | ST-3123.02 | 170 |
| ST-3223 | 120 | ST-3123 | 180 |
| ST-3383 | 130 | | |

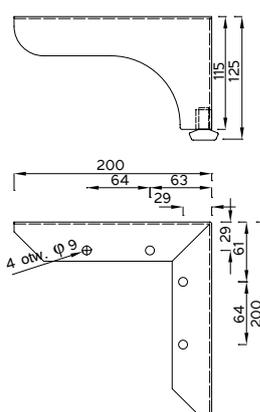
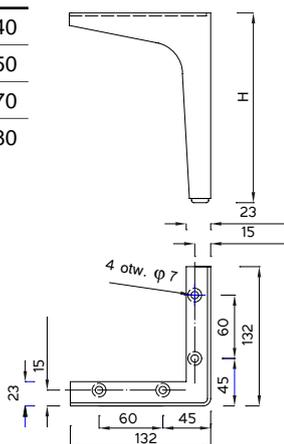

ST-3522



ST-3706

New

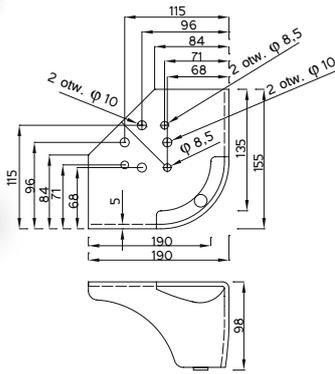

ST-3707

New

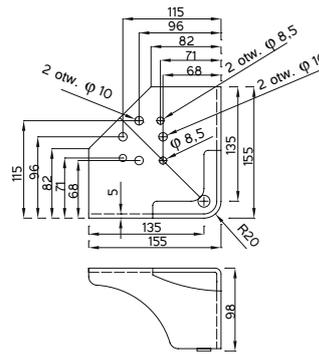

ST

ST-7791.021

New

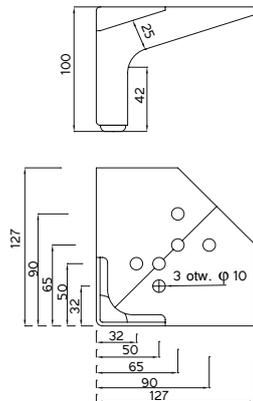

ST-3727

New



Noga prawa i lewa

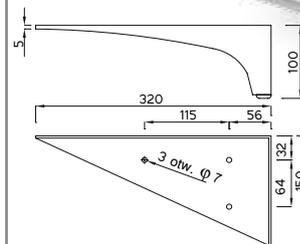

ST-3734

New

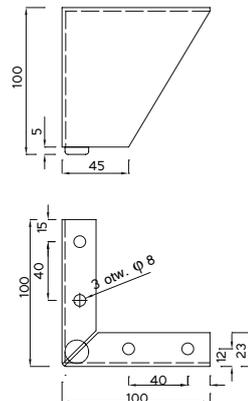

ST-7688

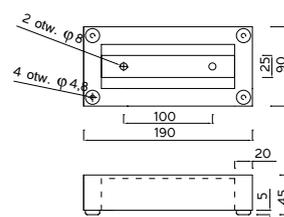

| Nr katalogowy | H |
|---------------|----|
| ST-3023.05 | 25 |
| ST-3023 | 40 |
| ST-3023.02 | 55 |

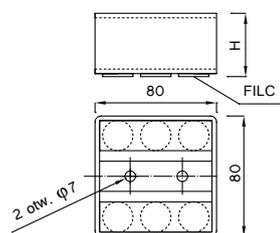

ST-3061

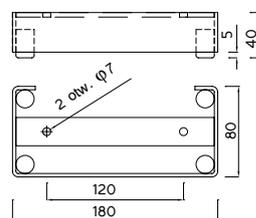



IS

ST-3267

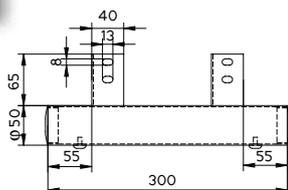

| Nr katalogowy | L | φ |
|---------------|-----|----|
| ST-3087 | 120 | 60 |
| ST-3108 | 150 | 60 |
| ST-3149 | 165 | 50 |
| ST-3086 | 170 | 60 |
| ST-3149.03 | 220 | 40 |
| ST-3149.01 | 230 | 50 |
| ST-3085 | 280 | 60 |

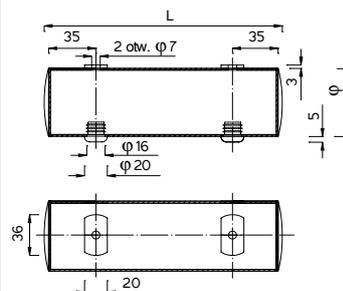

| Nr katalogowy | L |
|---------------|-----|
| ST-3020.01 | 185 |
| ST-3020 | 225 |
| ST-3020.05 | 250 |
| ST-3020.06 | 400 |

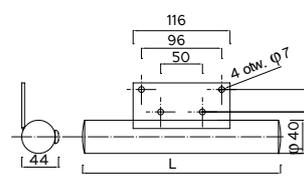

ST-3054

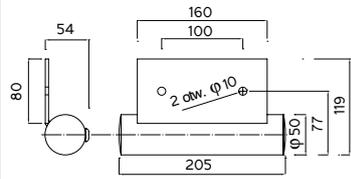

| Nr katalogowy | L |
|---------------|-----|
| ST-3144 | 80 |
| ST-3198 | 120 |
| ST-3294 | 145 |
| ST-3145 | 160 |
| ST-3198.01 | 165 |
| ST-3145.01 | 220 |

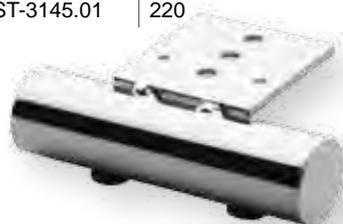
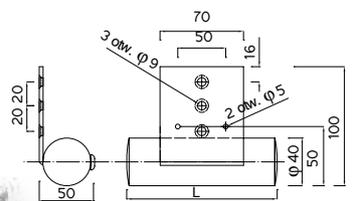

ST-3416

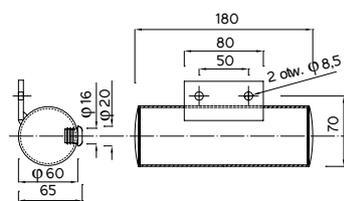

| Nr katalogowy | L | φ |
|---------------|-----|----|
| ST-3480 | 150 | 32 |
| ST-3472 | 180 | 40 |

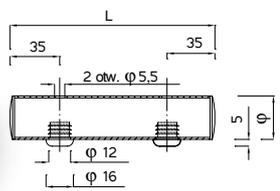

| Nr katalogowy | L | φ |
|---------------|-----|----|
| ST-3005 | 100 | 40 |
| ST-3003 | 120 | 40 |
| ST-3007 | 120 | 50 |
| ST-3132 | 120 | 60 |
| ST-3321 | 140 | 60 |

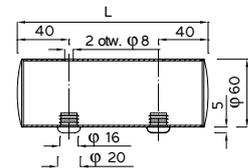

| Nr katalogowy | L | φ |
|---------------|-----|----|
| ST-3008 | 160 | 50 |
| ST-3124 | 160 | 60 |
| ST-3004 | 165 | 40 |
| ST-3008.02 | 220 | 50 |
| ST-3006 | 225 | 60 |



ST-3586

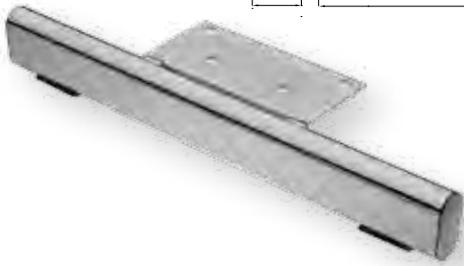
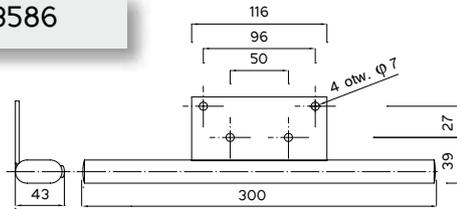

Nr katalogowy

L

ST-3547

270

ST-3547.01

200

ST

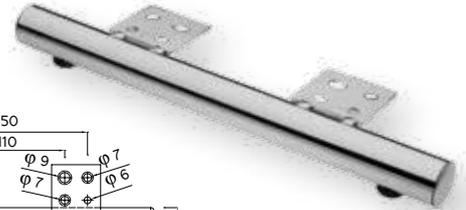
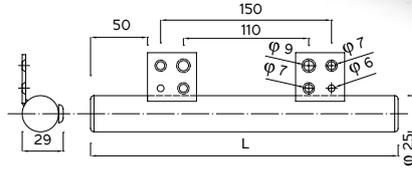

ST-3579

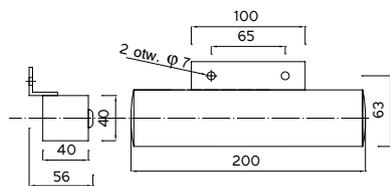

ST-3580

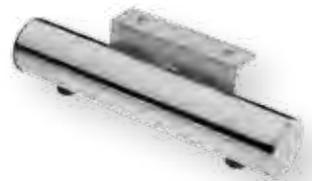
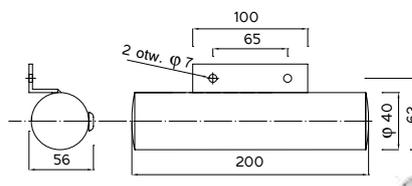

ST-3584

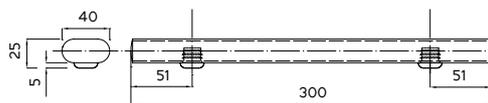

ST-3585

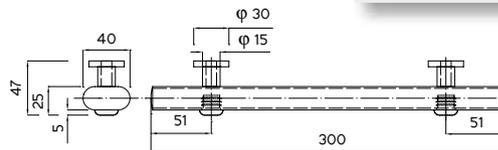

ST-3549

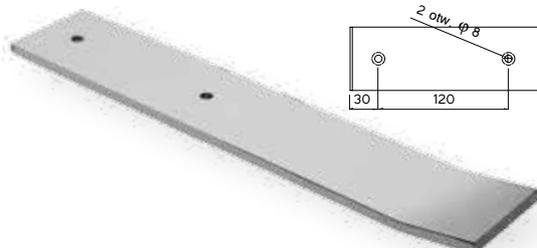
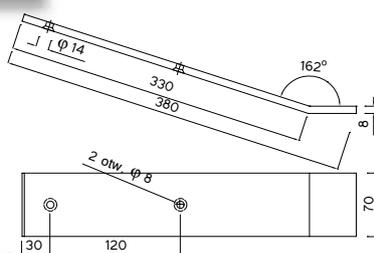

ST-3578

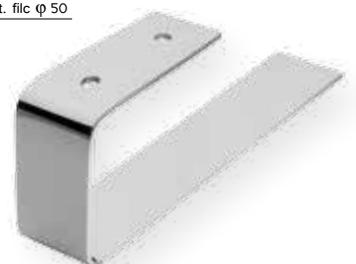
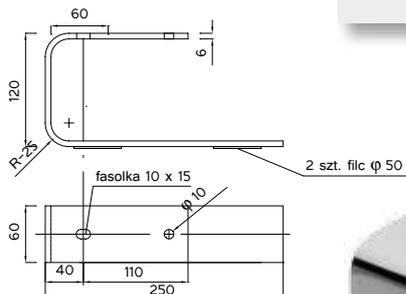



IS

| Nr katalogowy | H | L1 | L2 |
|---------------|-----|-----|-----|
| ST-3200 | 65 | 140 | 74 |
| ST-3175 | 65 | 180 | 115 |
| ST-3200.01 | 80 | 120 | 54 |
| ST-3175.02 | 100 | 150 | 84 |

| Nr katalogowy | L |
|---------------|-----|
| ST-3150.02 | 100 |
| ST-3115 | 140 |
| ST-3150 | 195 |
| ST-3116 | 215 |

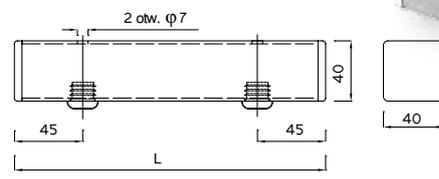
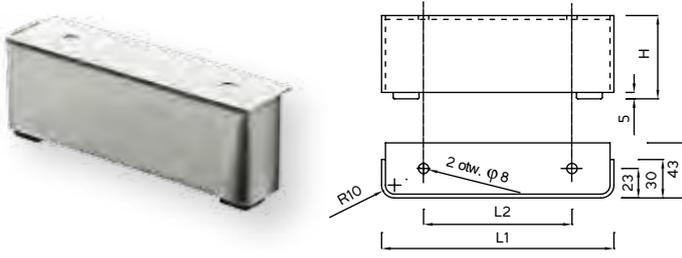

ST-7667

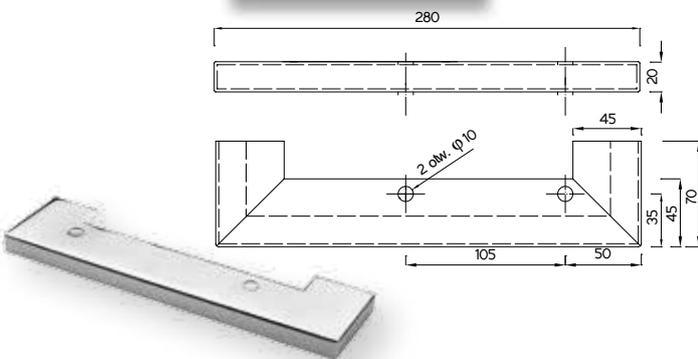

ST-3624

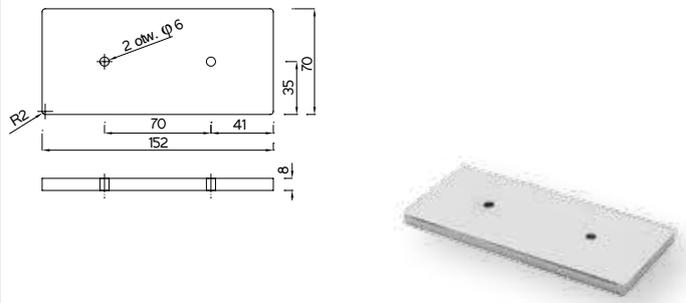

ST-7668

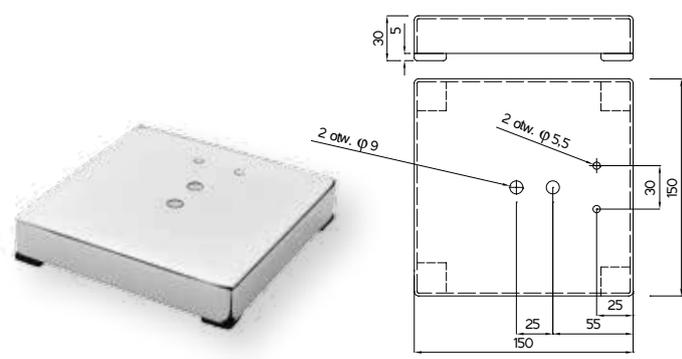

| Nr katalogowy | H |
|---------------|-----|
| ST-7664 | 80 |
| ST-7664.01 | 100 |

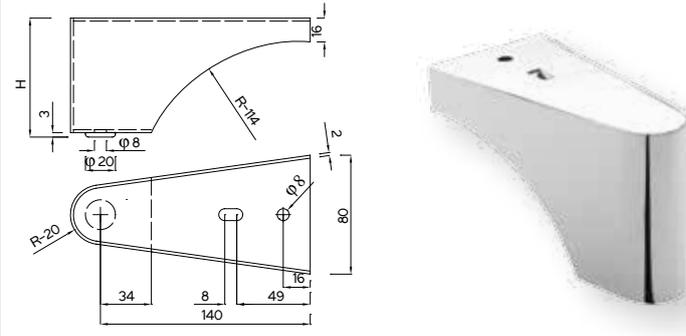

ST-3479

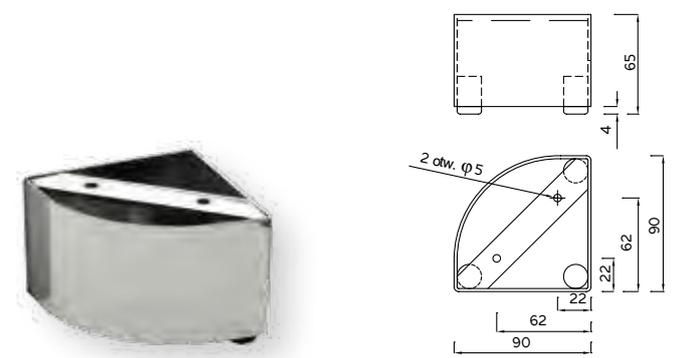

ST-3434.15

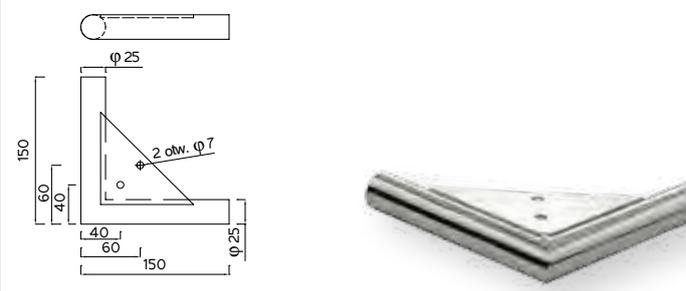



IS

ST-3652

New

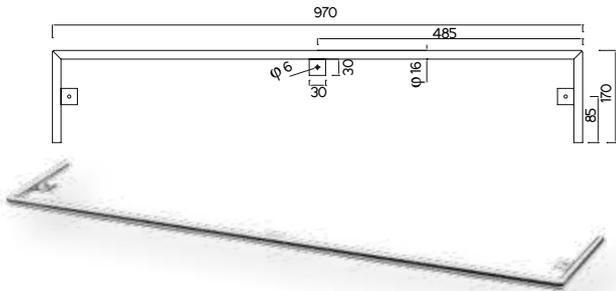

ST-3733

New

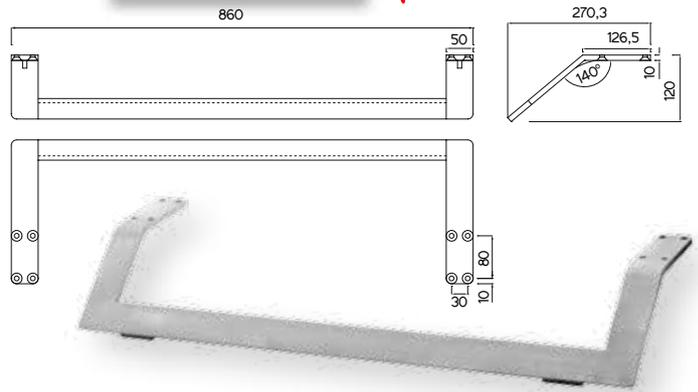

ST-3724

New

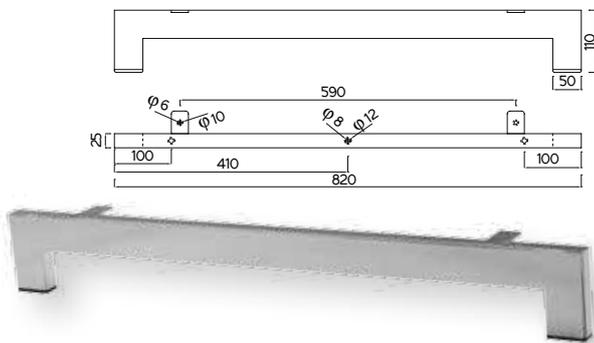

ST-7682

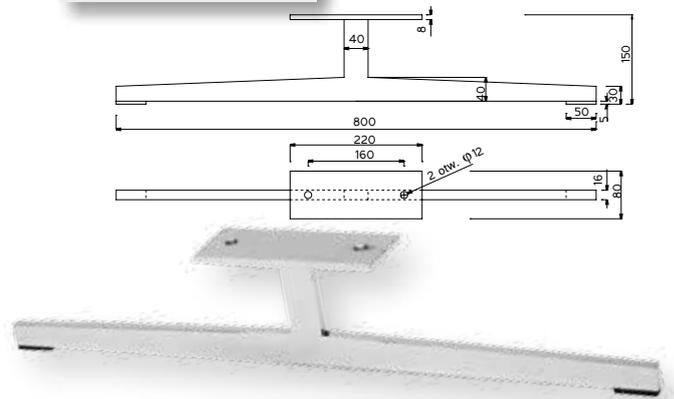

ST-3619

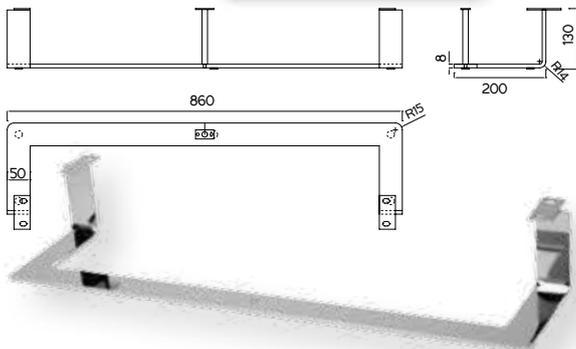

ST-3635

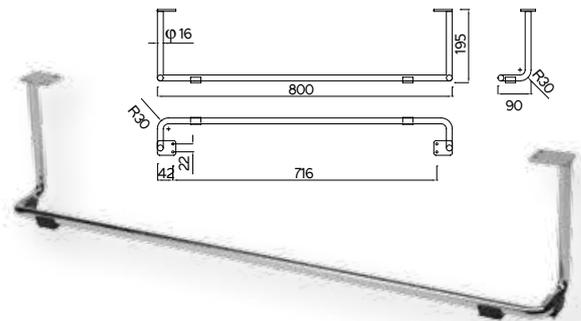

ST-3626

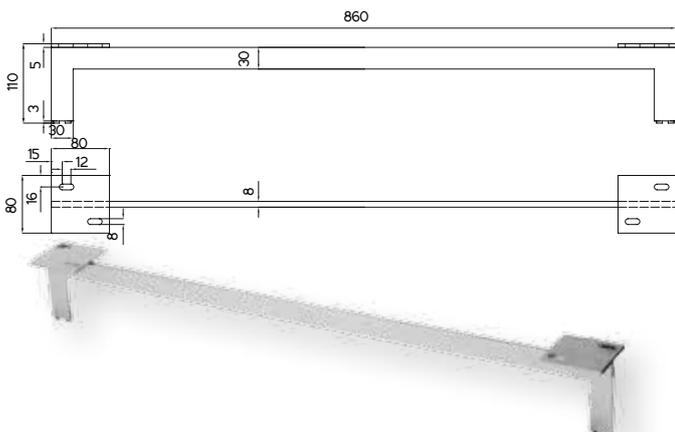

ST-3614

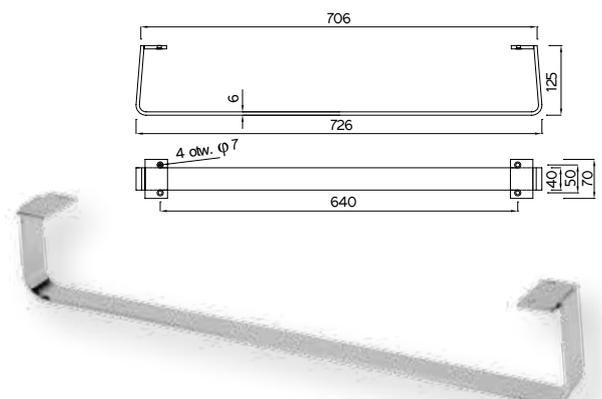



IS

ST-3731

New

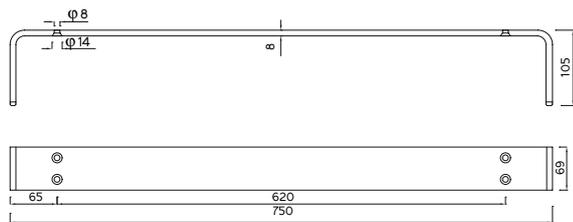

ST-3732

New

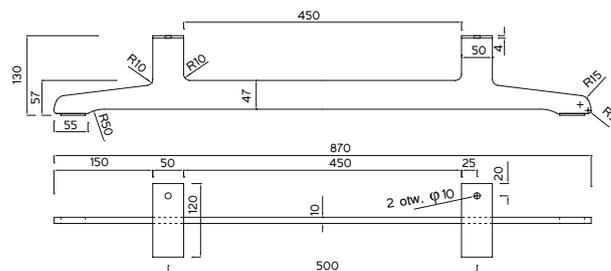

ST-3669

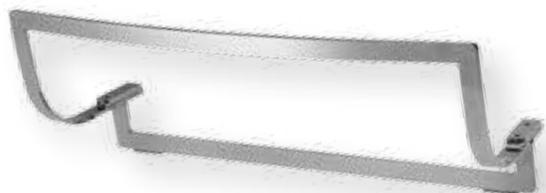
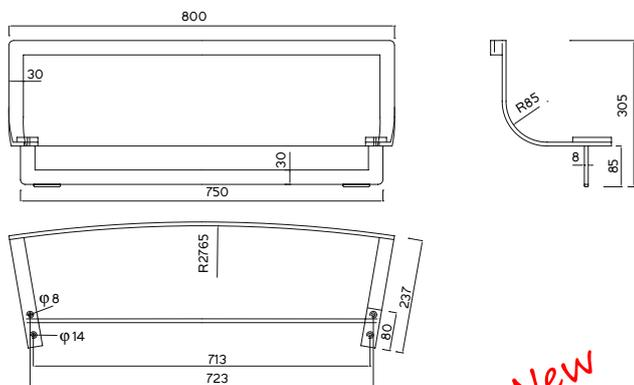

New

ST-3715

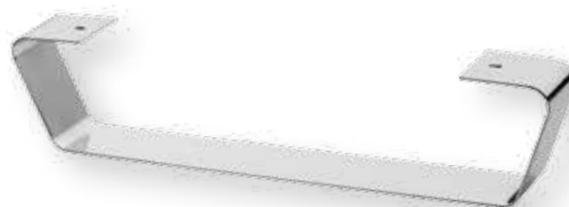
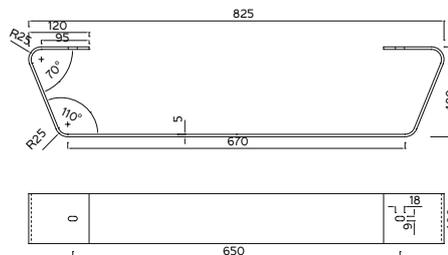

New

ST-3474

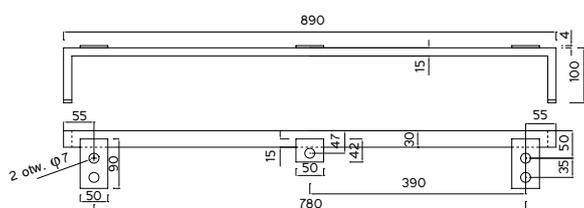

ST-3331

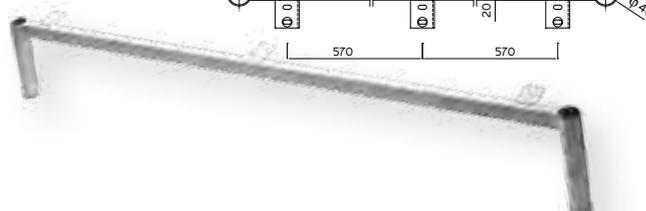
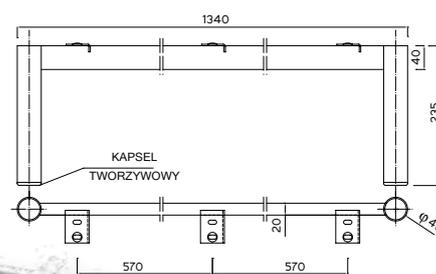

ST-3022

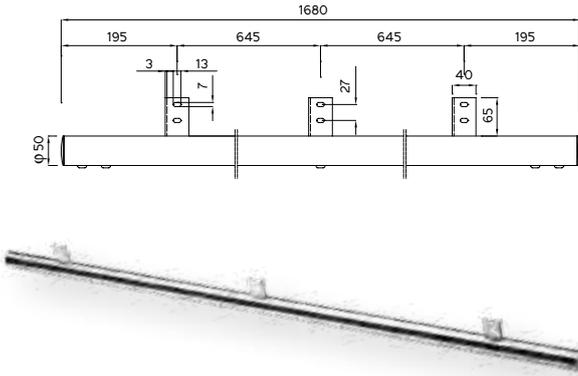

ST-3517

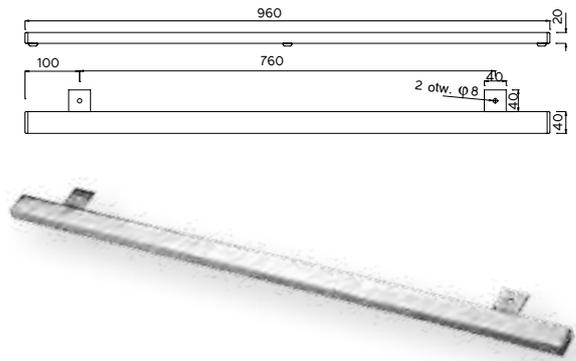

ST

ST-3404

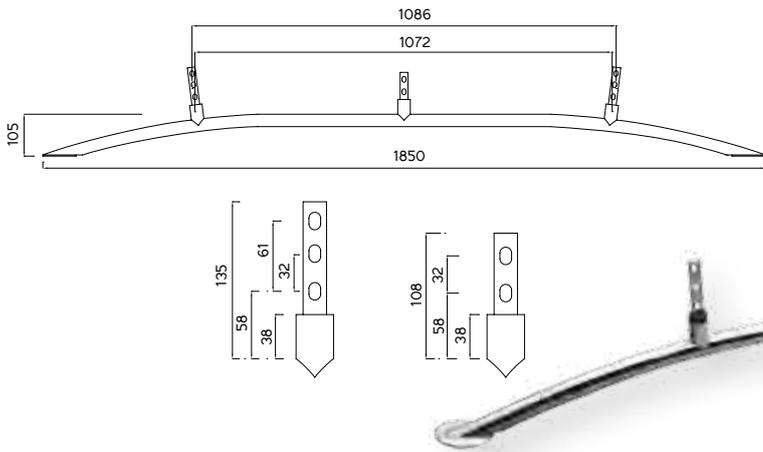

ST-3548

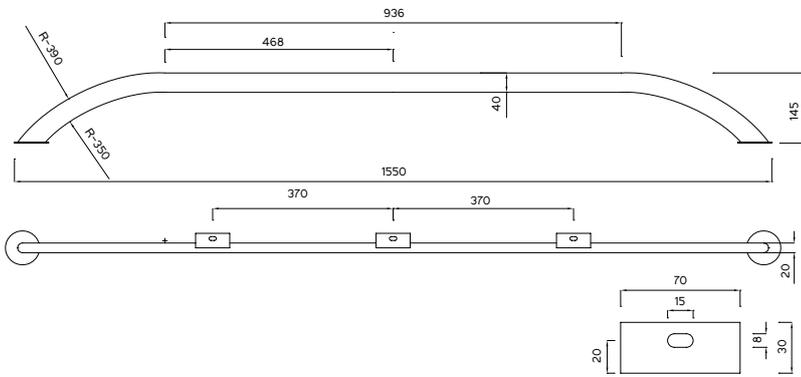

| Nr katalogowy | L | L1 |
|---------------|------|------|
| ST-7228 | 985 | 330 |
| ST-7229 | 1435 | 600 |
| ST-3566 | 1935 | 1180 |

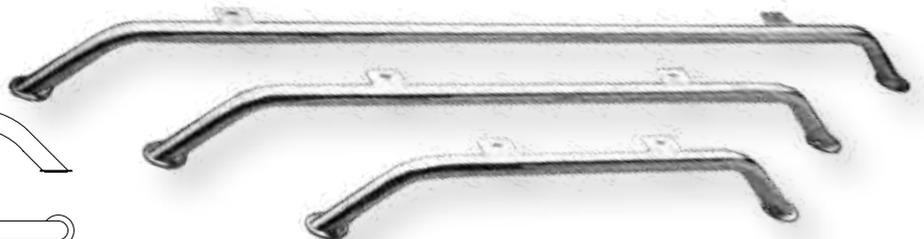
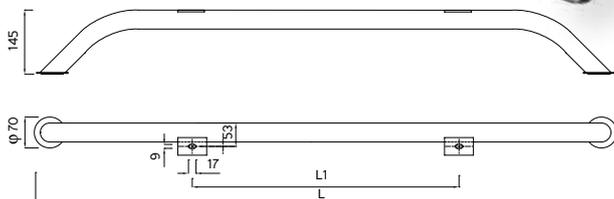



IS

ST-3599.04

New

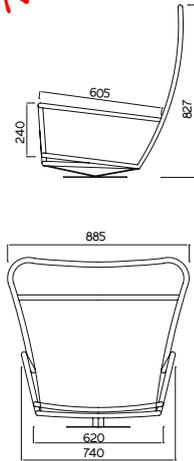
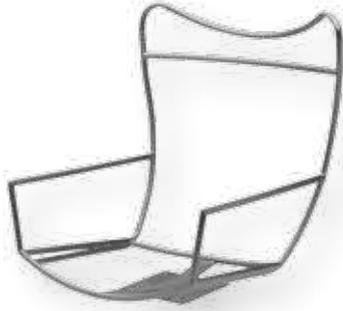

ST-3599

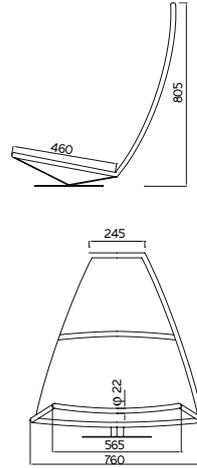

ST-3621

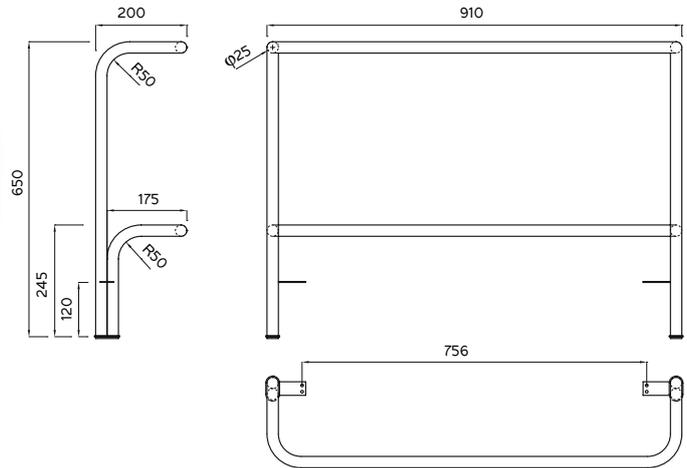

ST-3728

New

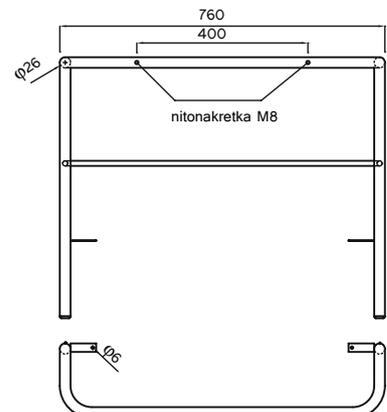
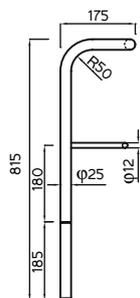

ST-3434

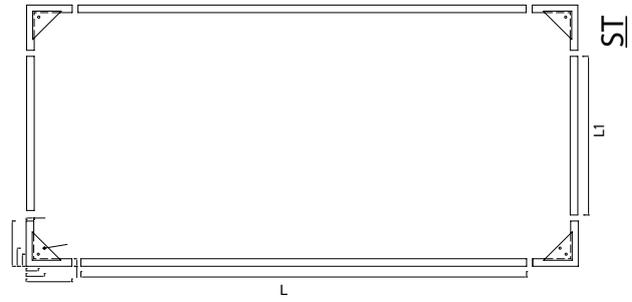
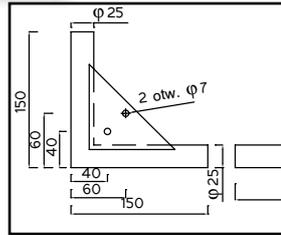

ST-3448

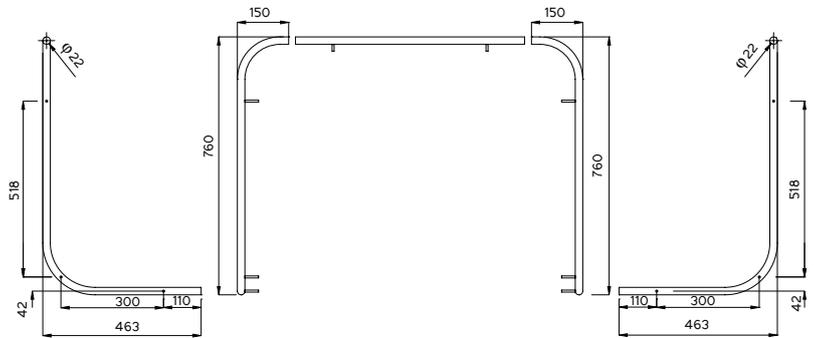

ST-3730

New

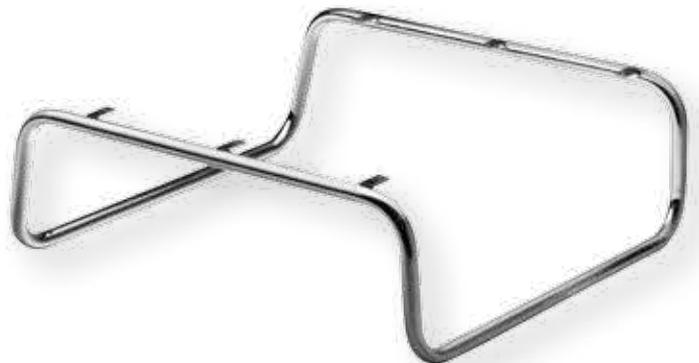
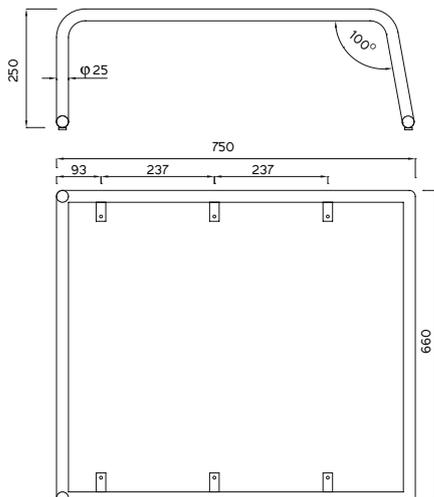



IS

ST-3581

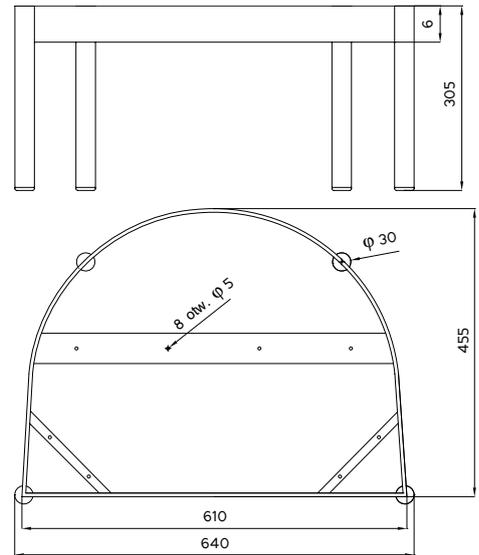

ST-3663

New

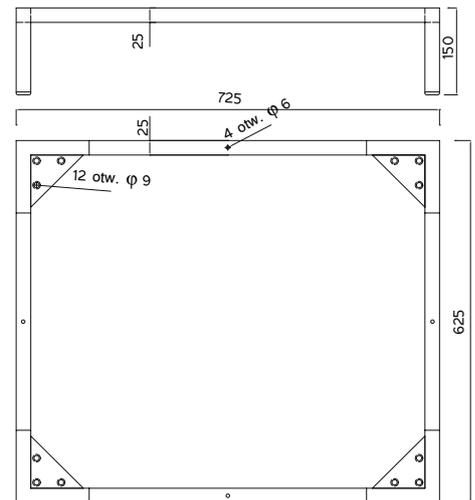

ST-3628

New

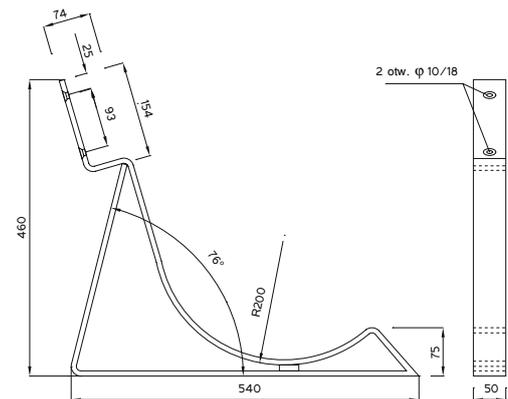



ST

ST-3604

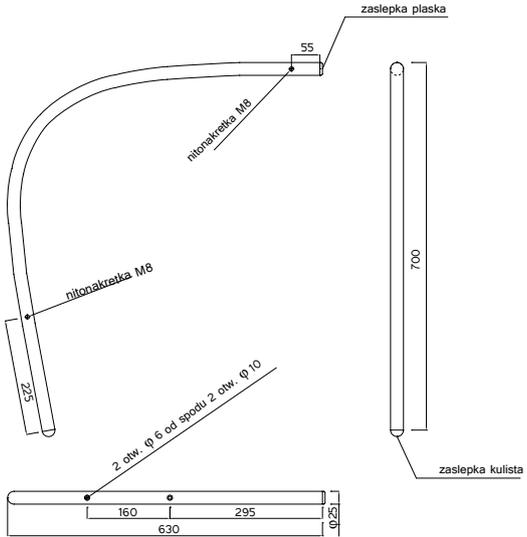

ELEMENT PRAWY I LEWY

ST-3729

New

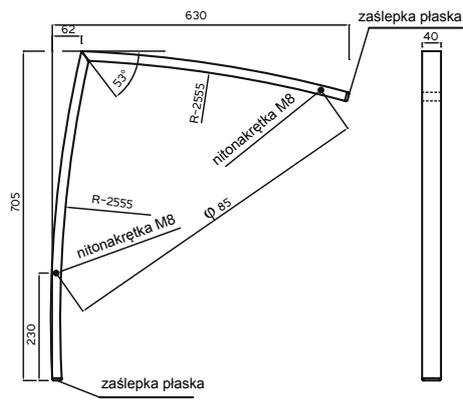

ELEMENT PRAWY I LEWY

ST-3689.01

New

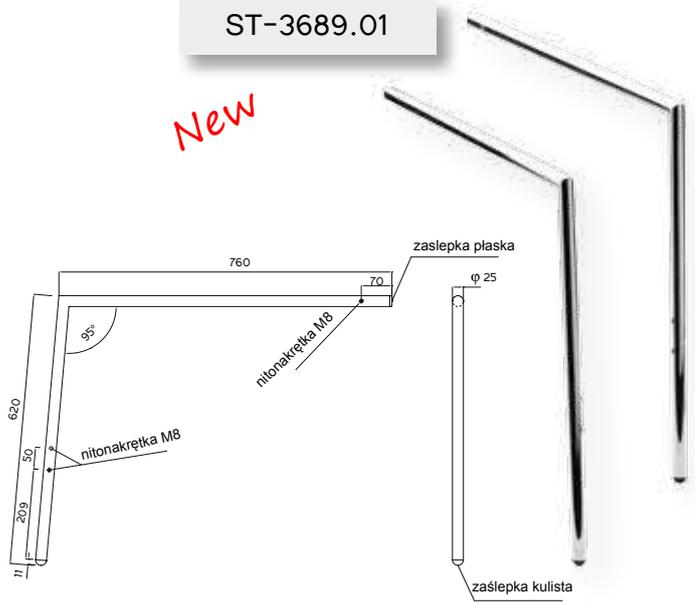

ELEMENT PRAWY I LEWY

ST-3703

New



ELEMENT PRAWY I LEWY



IS

ST-7526

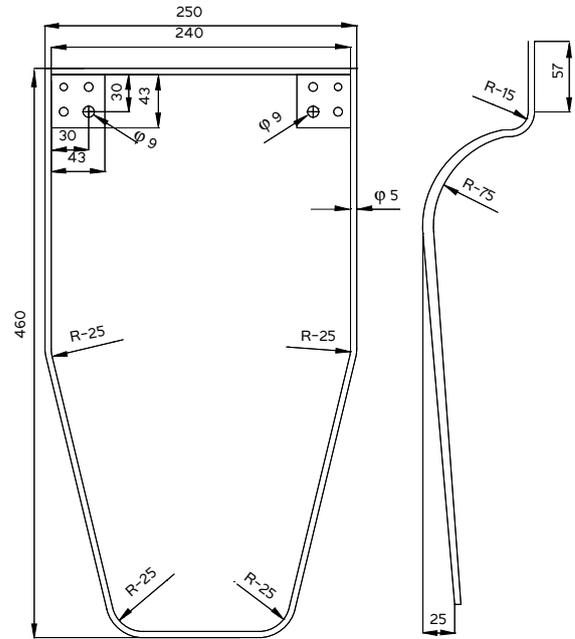

ST-7542

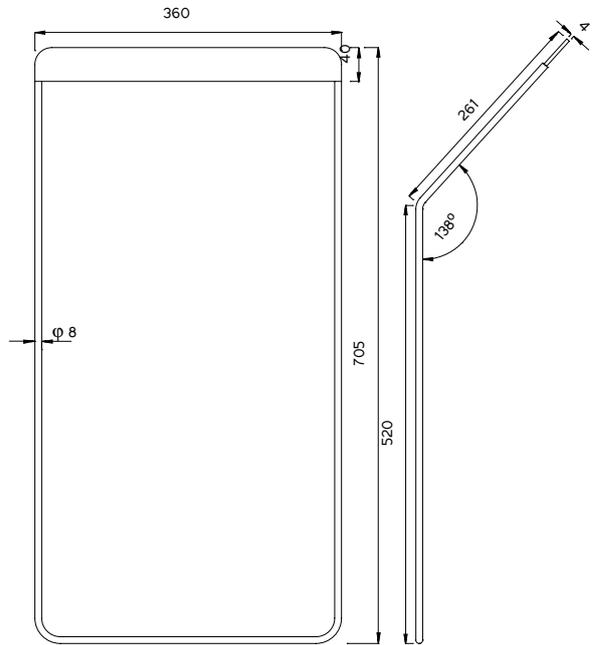

| Nr katalogowy | D | L | L1 | L2 |
|---------------|---|-----|----|----|
| ST-6162 | 8 | 60 | 10 | 40 |
| ST-6162.01 | 8 | 80 | 10 | 40 |
| ST-6162.02 | 8 | 90 | 10 | 40 |
| ST-6153 | 8 | 110 | 40 | 40 |
| ST-6155 | 8 | 130 | 40 | 40 |

| Nr katalogowy | D | L |
|---------------|---|----|
| ST-6164 | 8 | 60 |
| ST-6168 | 8 | 80 |

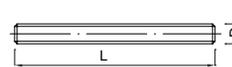
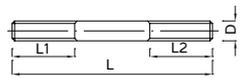



ST-3482

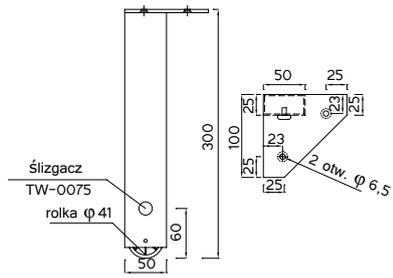

ST-3473

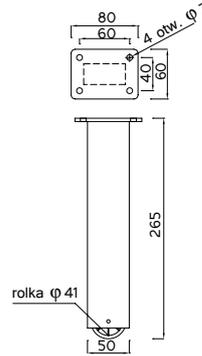

ST

ST-3721.01

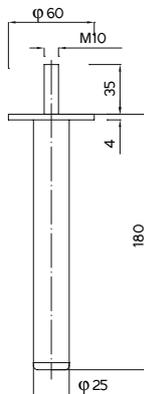

ST-3127

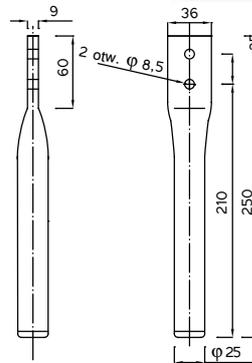

ST-7238

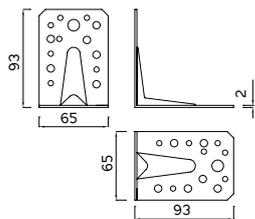

ST-7268.01

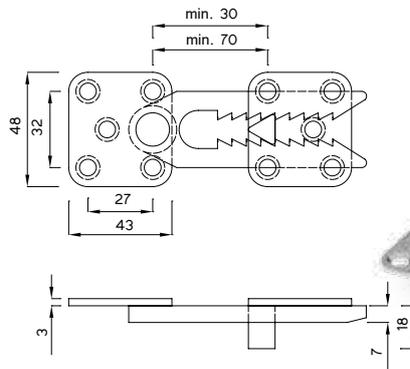

ST-3155

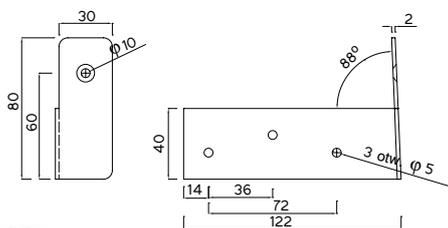
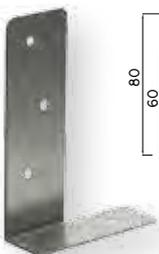

ST-7723

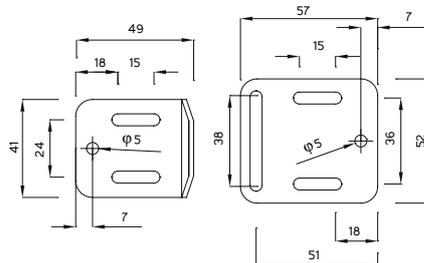

biały



popiel



olcha



beż



RAL 8003



RAL 8004



czarny

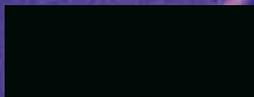

Wyroby z tworzyw sztucznych, podkładki filcowe TW

Plastic goods, felt pads
Kunststoffmöbelzubehör, Filzunterlagen
Изделия из пластмасс, фетровые подкладки

| Nr katalogowy | L1 | L2 | L3 | H |
|---------------|-----|-----|-----|----|
| TW-0559 | 160 | 150 | 65 | 50 |
| TW-0399 | 160 | 151 | 65 | 67 |
| TW-0534 | 200 | 190 | 110 | 67 |
| TW-0406 | 280 | 270 | 192 | 67 |
| TW-0427 | 320 | 310 | 232 | 67 |

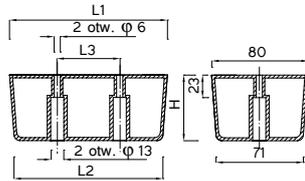

TW-0495

TW

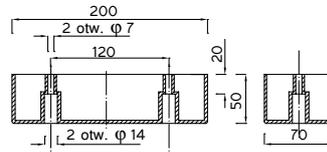

TW-0544.02

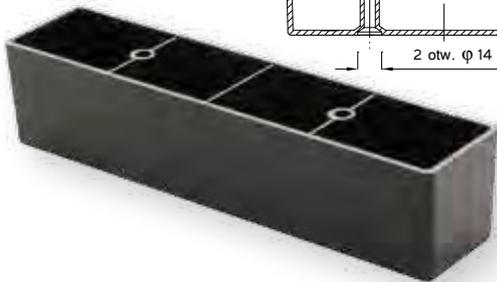
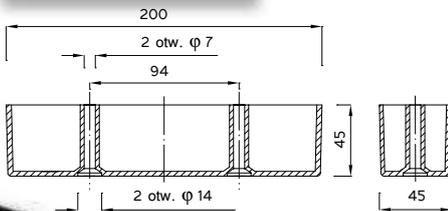

TW-0613

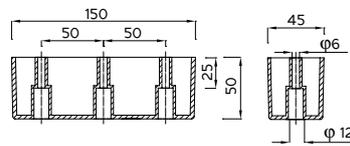

| Nr katalogowy | H | L | L1 | H1 |
|---------------|-----|-----|----|----|
| ■ TW-0201 | 60 | 105 | 80 | 40 |
| ■ TW-0638 | 67 | 100 | 80 | 32 |
| TW-0458 | 80 | 100 | 80 | 45 |
| TW-0470 | 100 | 100 | 75 | 45 |

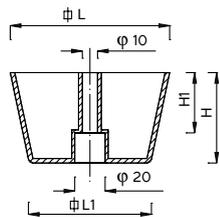

| Nr katalogowy | H | L | L1 | H1 |
|---------------|-----|-----|----|----|
| TW-0531 | 80 | 100 | 80 | 45 |
| TW-0531.01 | 100 | 100 | 75 | 45 |

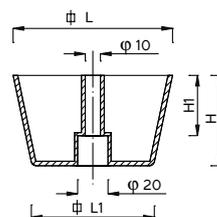

TW-0532

TW-0527

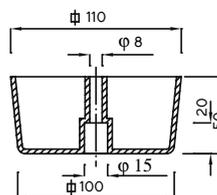
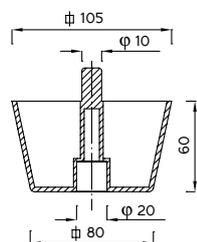



TW

| Nr katalogowy | H |
|---------------|----|
| TW-0162 | 45 |
| TW-0357 | 55 |

TW-0357.04

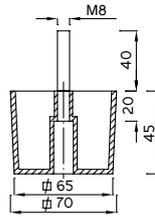
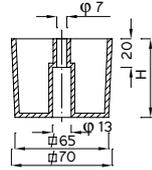

TW-0546

TW-0556

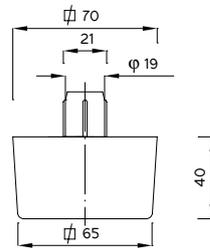
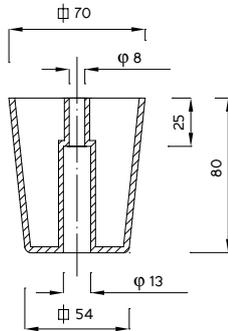

TW-0648

TW-0643

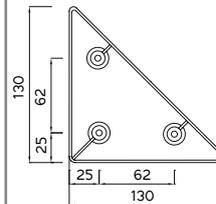
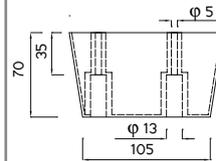
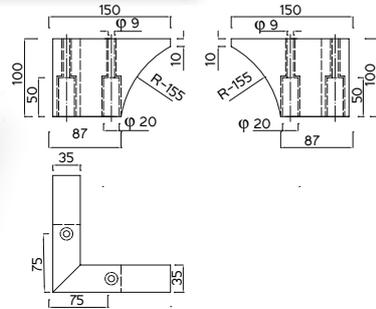

TW-0476

TW-0475

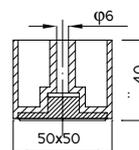
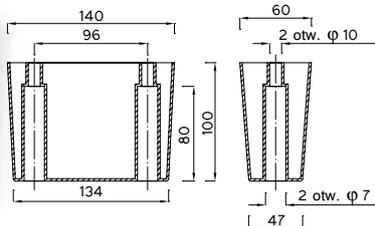

TW-0647

New

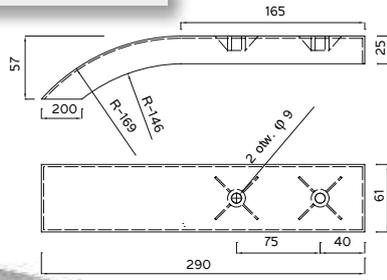

TW-0635.01

TW



New

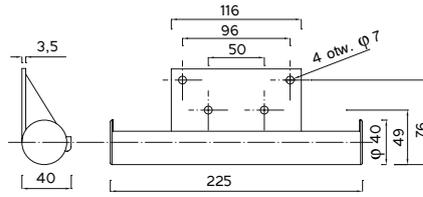

TW-0472

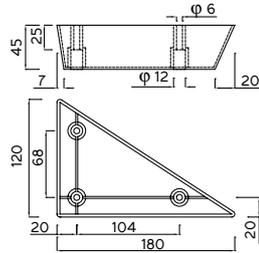

Noga prawa i lewa

TW-0517

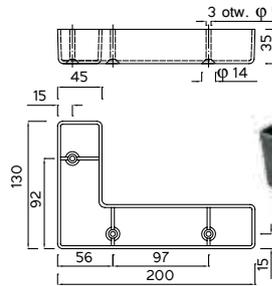

Noga prawa i lewa

| Nr katalogowy | H |
|---------------|----|
| TW-0483 | 45 |
| TW-0483.05 | 60 |

TW-0488.03

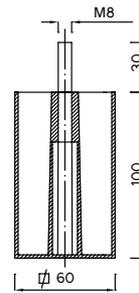
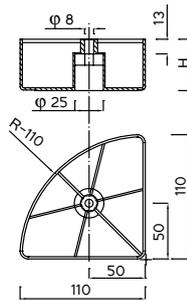

TW-0615

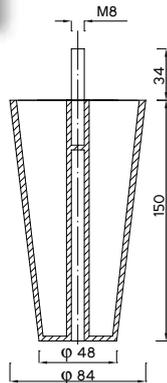

TW-0614

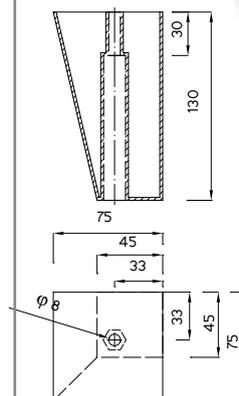



TW

| Nr katalogowy | M |
|---------------|----|
| TW-0018 | 8 |
| TW-0023 | 10 |

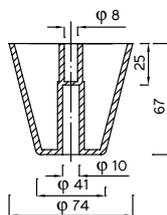
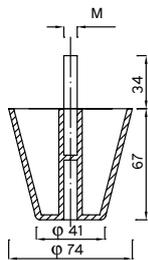

TW-0024

| Nr katalogowy | H |
|--------------------------|-----|
| Nowość TW-0168.01 | 70 |
| TW-0168.05 | 82 |
| TW-0168 | 88 |
| TW-0169 | 120 |
| TW-0525 | 130 |

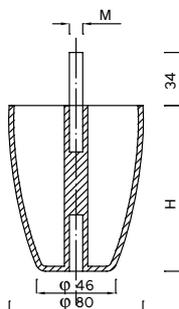
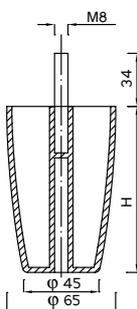

| Nr katalogowy | H | M |
|---------------|-----|----|
| TW-0003 | 90 | 8 |
| TW-0006 | 90 | 10 |
| TW-0001 | 100 | 8 |
| TW-0142 | 110 | 8 |
| TW-0143 | 110 | 10 |



| Nr katalogowy | M |
|---------------|----|
| TW-0195 | 8 |
| TW-0194 | 10 |

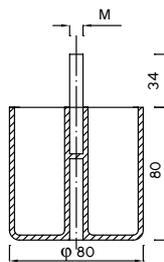
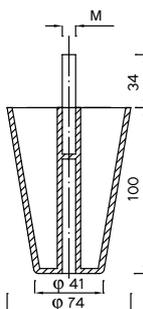

| Nr katalogowy | M |
|---------------|----|
| TW-0009 | 8 |
| TW-0012 | 10 |



| Nr katalogowy | H | φ |
|---------------|----|----|
| TW-0332 | 70 | 50 |
| TW-0016 | 80 | 50 |

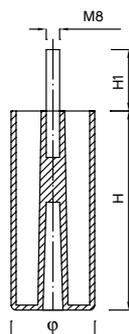
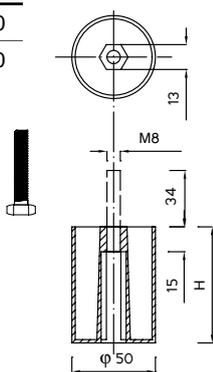

| Nr katalogowy | H | φ | H1 |
|--------------------------|-----|----|----|
| Nowość TW-0192.03 | 60 | 50 | 30 |
| TW-0503 | 90 | 50 | 35 |
| TW-0017 | 100 | 50 | 35 |
| TW-0494 | 100 | 60 | 35 |
| Nowość TW-0636 | 105 | 50 | 35 |
| TW-0013 | 110 | 50 | 35 |
| TW-0015 | 120 | 50 | 35 |
| TW-0494.01 | 120 | 60 | 35 |
| TW-0014.01 | 130 | 50 | 40 |
| TW-0014 | 135 | 50 | 35 |
| TW-0597 | 150 | 50 | 35 |
| TW-0494.02 | 150 | 60 | 35 |
| Nowość TW-0645 | 160 | 50 | 25 |



| Nr katalogowy | M |
|---------------|----|
| TW-0177 | 8 |
| TW-0178 | 10 |

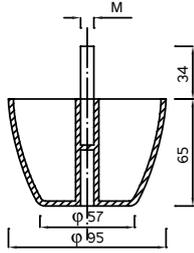

| Nr katalogowy | M |
|---------------|----|
| TW-0172 | 8 |
| TW-0171 | 10 |

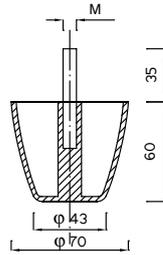

TW-0499

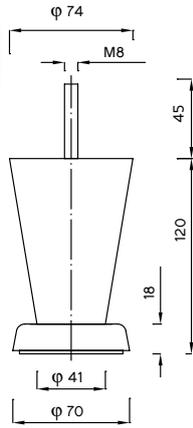

TW-0497

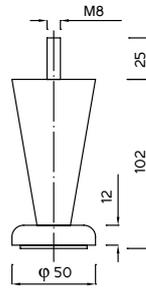

| Nr katalogowy | H |
|---------------|-----|
| TW-0500 | 85 |
| TW-0500.01 | 100 |
| TW-0500.02 | 140 |

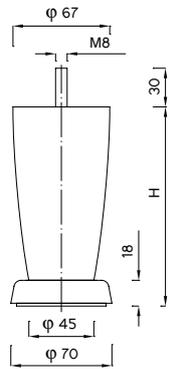

| Nr katalogowy | H |
|---------------|-----|
| TW-0498 | 90 |
| TW-0498.01 | 100 |
| TW-0498.02 | 120 |
| TW-0498.03 | 140 |

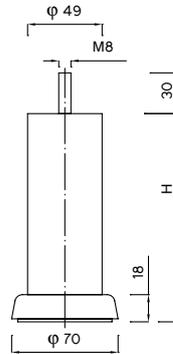

TW-0501

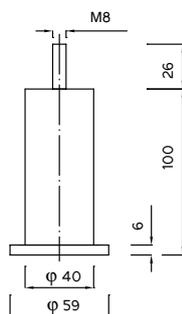

| Nr katalogowy | H | H1 |
|---------------|-----|----|
| TW-0496.07 | 50 | 25 |
| TW-0496 | 100 | 25 |
| TW-0496.01 | 100 | 35 |
| TW-0496.02 | 110 | 25 |
| TW-0496.03 | 110 | 35 |
| TW-0496.05 | 150 | 30 |

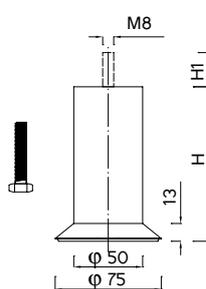



TWI

TW-0203

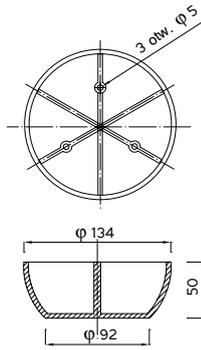

TW-0339

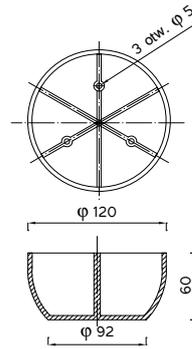

TW-0053

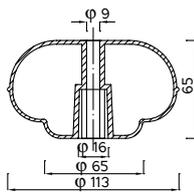

TW-0055

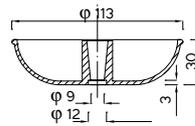

TW-0185

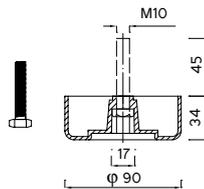

TW-0356.01

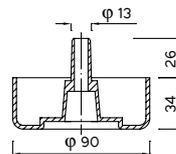

TW-0356

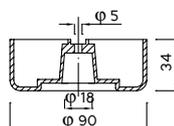

TW-0196

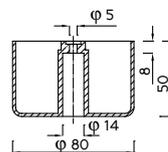



TW-0621

New

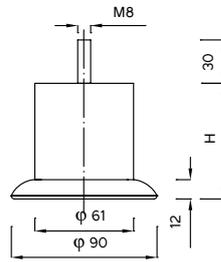
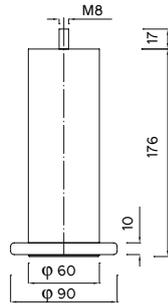

| Nr katalogowy | H |
|---------------|-----|
| TW-0502 | 70 |
| TW-0502.01 | 90 |
| TW-0502.02 | 100 |



| Nr katalogowy | H |
|---------------|----|
| TW-0036.04 | 45 |
| TW-0036 | 50 |
| TW-0037 | 60 |

TW-0619

New

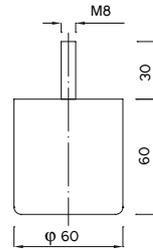
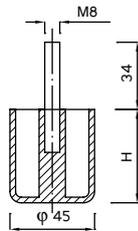

| Nr katalogowy | M |
|---------------|----|
| TW-0027 | 8 |
| TW-0032 | 10 |

| Nr katalogowy | H | φD |
|---------------|----|----|
| TW-0030 | 11 | 10 |
| TW-0029 | 22 | 13 |
| TW-0028 | 22 | 13 |

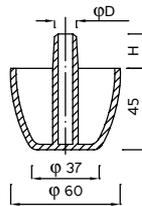
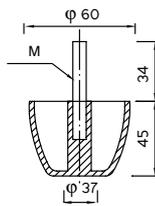

| Nr katalogowy | H |
|---------------|----|
| TW-0586 | 64 |
| TW-0586.01 | 82 |
| TW-0586.02 | 92 |

| Nr katalogowy | φ | H | H1 |
|---------------|-----|-----|----|
| TW-0429.01 | 80 | 60 | 20 |
| TW-0429.07 | 80 | 70 | 20 |
| TW-0429.02 | 80 | 80 | 35 |
| TW-0429.03 | 80 | 100 | 25 |
| TW-0429.12 | 100 | 80 | 20 |
| TW-0429.04 | 100 | 100 | 35 |
| TW-0429.05 | 100 | 120 | 25 |
| TW-0429.06 | 100 | 120 | 35 |

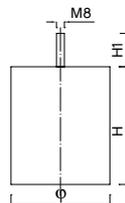
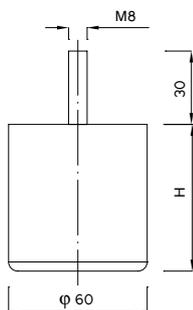



TW

TW-0331

| Nr katalogowy | H |
|---------------|----|
| TW-0047 | 25 |
| TW-0048 | 35 |

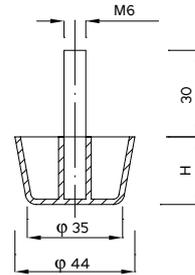
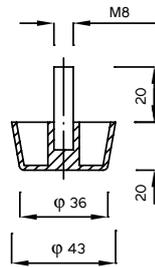

TW-0410

TW-7442

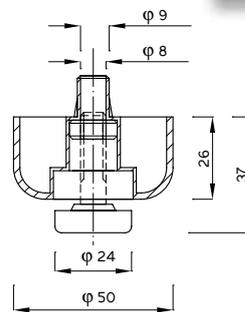
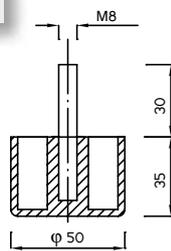

Stópka plastikowa φ 50 x 26
z regulacją wysokości do 37 mm

W komplecie zaślepka
na otwór φ 10 mm



| Nr katalogowy | H | H1 | A | C |
|---------------|----|----|----|----|
| TW-0052 | 15 | 19 | 39 | 31 |
| TW-0051 | 20 | 22 | 43 | 32 |
| TW-0050 | 25 | 12 | 44 | 30 |
| TW-0049 | 25 | 22 | 44 | 30 |
| TW-0176 | 40 | 22 | 45 | 30 |

TW-0069

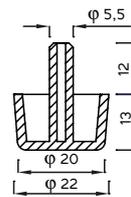
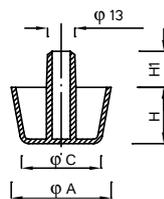

TW-0158

| Nr katalogowy | H |
|---------------|----|
| TW-0040 | 25 |
| TW-0043 | 35 |
| TW-0046 | 40 |
| TW-0193 | 45 |

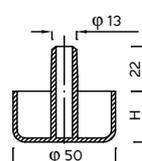
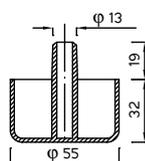



TW-7317

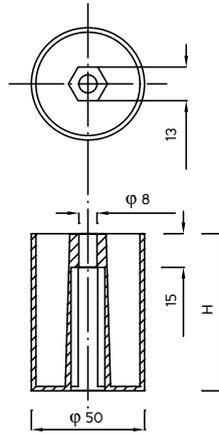
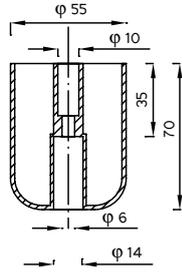

| Nr katalogowy | H |
|---------------|----|
| TW-0394 | 70 |
| TW-0016.05 | 80 |



| Nr katalogowy | H |
|---------------|----|
| TW-0161 | 28 |
| TW-0160 | 35 |

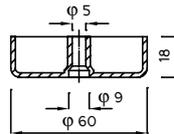
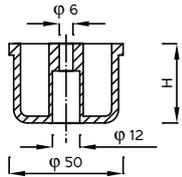

TW-0062



| Nr katalogowy | H |
|---------------|----|
| TW-0370 | 15 |
| TW-0434 | 20 |

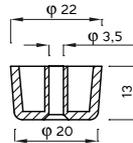
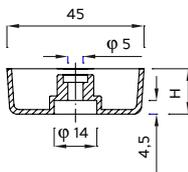

TW-0068



| Nr katalogowy | H |
|---------------|---------------------------------------|
| TW-0039 | 25 |
| TW-0626 | 30 ■ |
| TW-0042 | 35 |
| TW-0333 | 40 |
| TW-0549 | 45 |
| TW-0044 | 50 |
| TW-0192 | 60 |

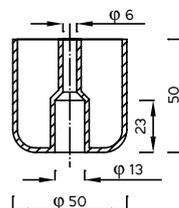
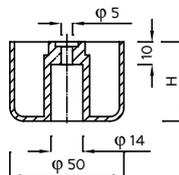

TW-0433





TW

TW-0060

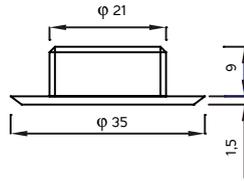

TW-0642

New

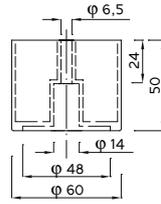

TW-0075

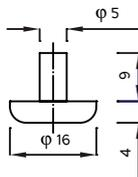

TW-0484

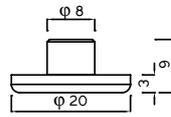

TW-0033

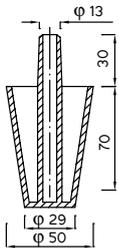

TW-0166

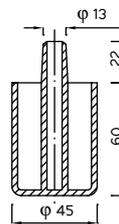

| Nr katalogowy | H |
|---------------|----|
| TW-0071 | 7 |
| TW-0072 | 10 |
| TW-0074 | 15 |

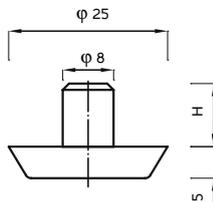

TW-0535

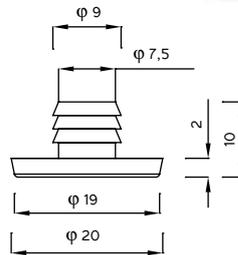

| Nr katalogowy | φ |
|---------------|----|
| TW-0083 | 8 |
| TW-0126 | 10 |

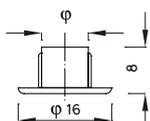

TW-0400

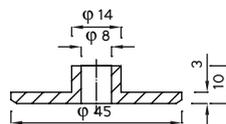

TW-0330

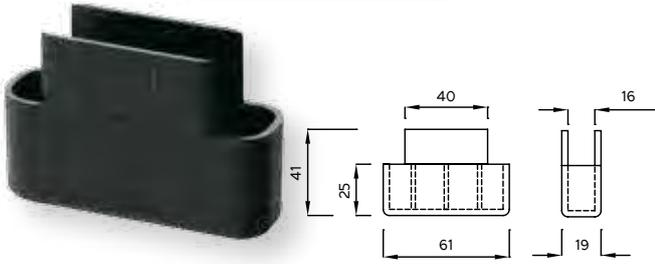

TW-0198

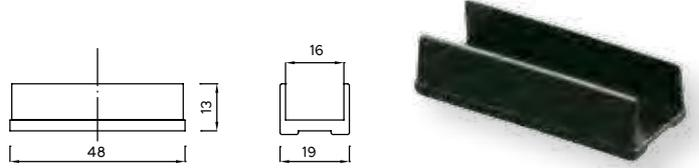

TW-0103



TW-0368



TW-0189

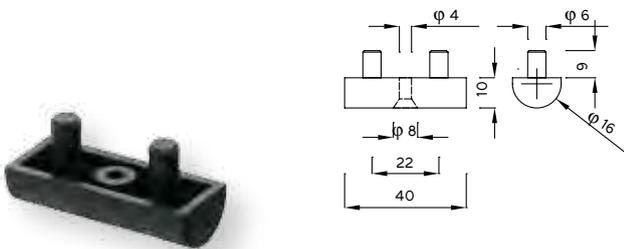

| Nr katalogowy | L |
|---------------|----|
| TW-0373 | 8 |
| TW-0415 | 10 |

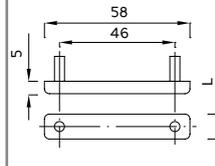

TW-0329



TW-0543

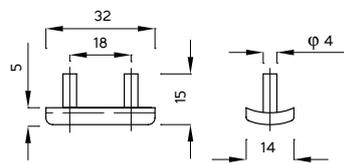

TW-0067



TW-0197





TW

TW-0199

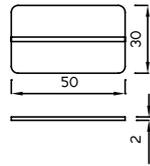

TW-0200

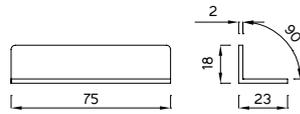

| Nr katalogowy | H |
|---------------|----|
| TW-7325 | 10 |
| TW-0063 | 15 |
| TW-0065 | 20 |
| TW-0064 | 25 |
| TW-7213 | 35 |

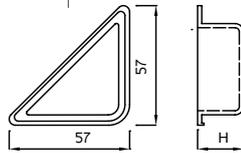

TW-0066

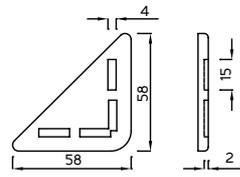

| Nr katalogowy | A | B | C |
|---------------|-----|----|----|
| TW-0599 | 100 | 36 | 14 |
| TW-0599.01 | 60 | 36 | 14 |

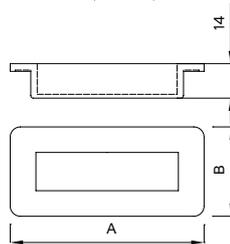

TW-0536

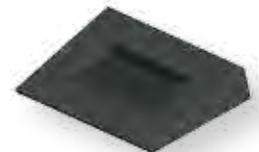
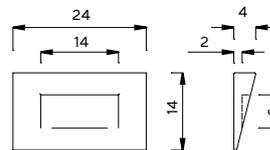

TW-0229

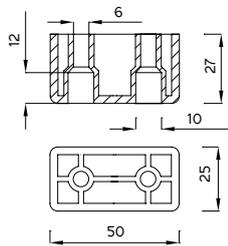

TW-0188

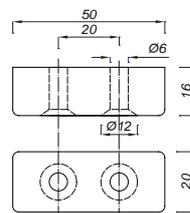

TW-0106

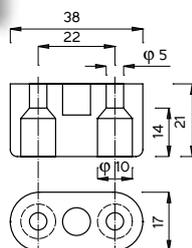

TW-0491

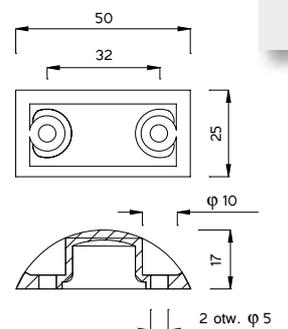

TW-0118

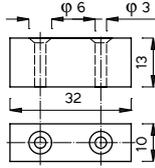

TW-0104

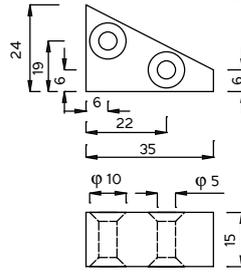

TW-0105

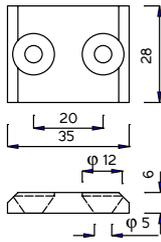

| Nr katalogowy | L | H |
|---------------|----|----|
| TW-0334 | 10 | 8 |
| TW-0117 | 15 | 10 |

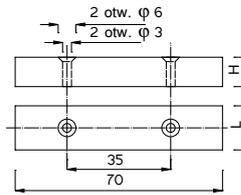

TW-0175

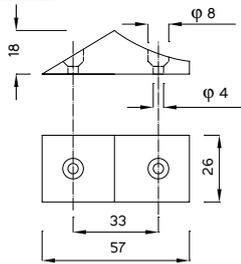

TW-0159

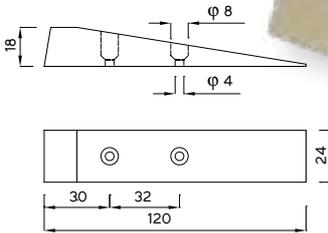

TW-7621

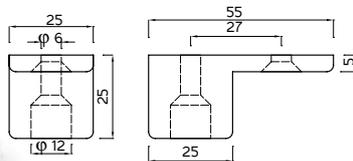

TW-0588

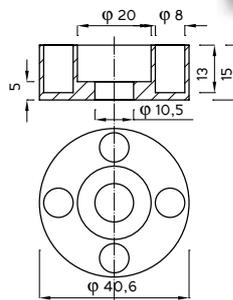

TW-0346

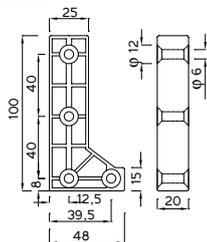

TW-0127

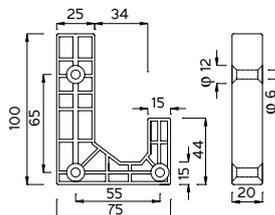



TW

TW-0365

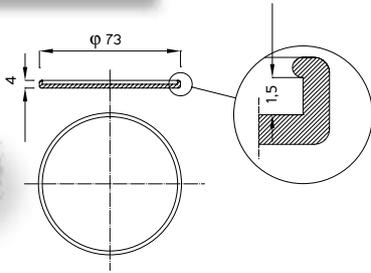

TW-0056

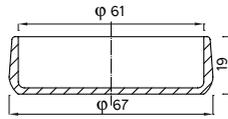

| Nr katalogowy | A, B |
|---------------|------|
| TW-0179 | 20 |
| TW-0180 | 25 |

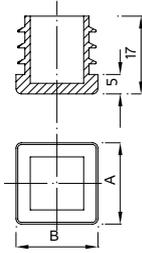

| Nr katalogowy | A | B | C | D | H | H1 |
|---------------|----|----|----|------|---|----|
| TW-0173 | 30 | 20 | 29 | 19 | 5 | 12 |
| TW-0174 | 32 | 15 | 29 | 12,5 | 3 | 12 |
| TW-0566 | 60 | 25 | 57 | 20 | 5 | 13 |

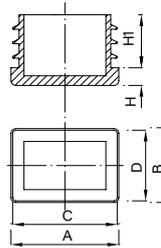

TW-0589

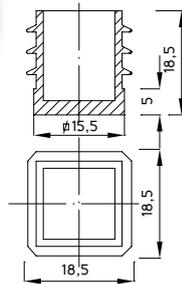

| Nr katalogowy | φ | H | M | φ1 |
|---------------|----|----|----|----|
| TW-0181 | 50 | 25 | 8 | 47 |
| TW-0182 | 60 | 25 | 8 | 57 |
| TW-0312 | 50 | 40 | 8 | 47 |
| TW-0313 | 60 | 40 | 8 | 57 |
| TW-0314 | 50 | 25 | 10 | 47 |
| TW-0315 | 60 | 25 | 10 | 57 |
| TW-0316 | 50 | 40 | 10 | 47 |
| TW-0317 | 60 | 40 | 10 | 57 |
| TW-7670 | 70 | 25 | 8 | 66 |

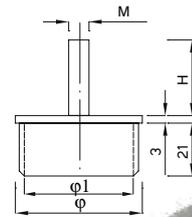

| Nr katalogowy | φ |
|---------------|----|
| TW-0506.01 | 32 |
| TW-0510 | 40 |
| TW-0058 | 50 |
| TW-0057 | 60 |
| TW-7683 | 70 |

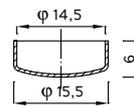
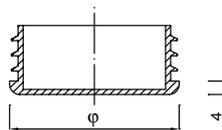

TW-0183



TW-0059.01

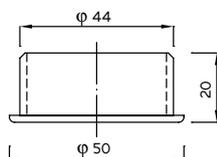

TW-0382

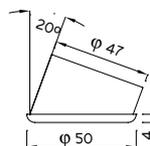

TW-0233

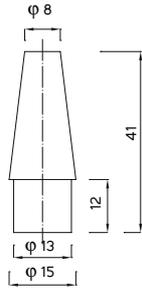

| Nr katalogowy | φ |
|---------------|----|
| TW-0468 | 16 |
| TW-0469 | 19 |
| TW-0506 | 22 |

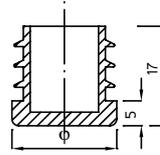

TW-0061

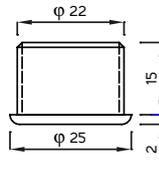

TW-0190

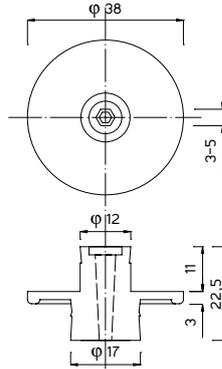

TW-0125

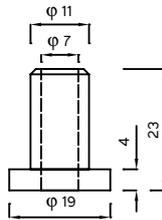

TW-0612

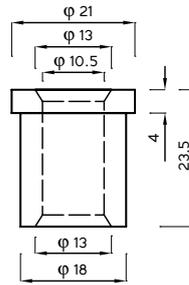

| Nr katalogowy | L |
|---------------|----|
| TW-0092 | 35 |
| TW-0093 | 40 |
| TW-0091 | 51 |

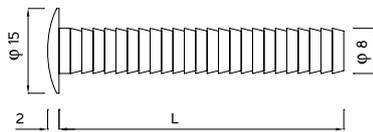

TW-0087

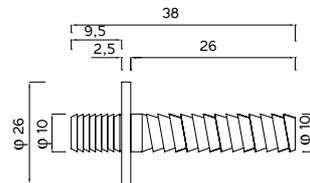

| Nr katalogowy | L | L1 |
|---------------|-----|------|
| TW-0089 | 1,5 | 33,5 |
| TW-0089.01 | 2,5 | 45,0 |

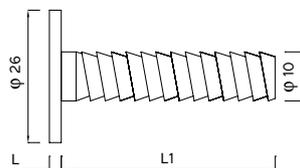

TW-0085

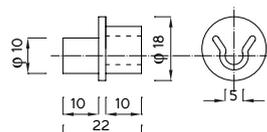

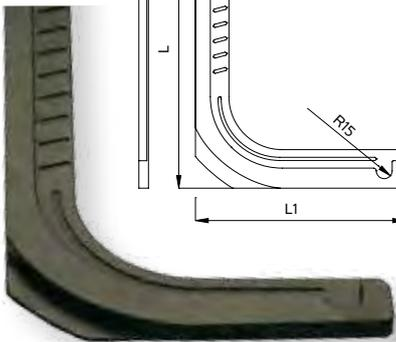
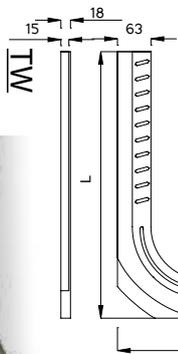

| Nr katalogowy | L | L1 |
|---------------|-----|-----|
| TW-0132 | 380 | 325 |
| TW-0133 | 390 | 325 |
| TW-0134 | 395 | 325 |
| TW-0135 | 420 | 325 |
| TW-0136 | 430 | 325 |
| TW-0137 | 440 | 325 |
| TW-0138 | 455 | 325 |
| TW-0139 | 460 | 325 |
| TW-0140 | 495 | 325 |
| TW-0141 | 505 | 325 |
| TW-0141.01 | 505 | 395 |

TW-2014

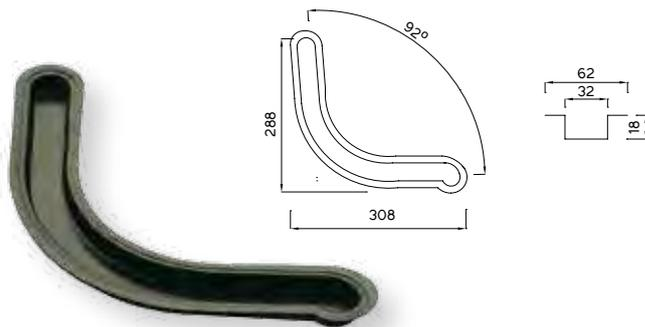

TW-2012

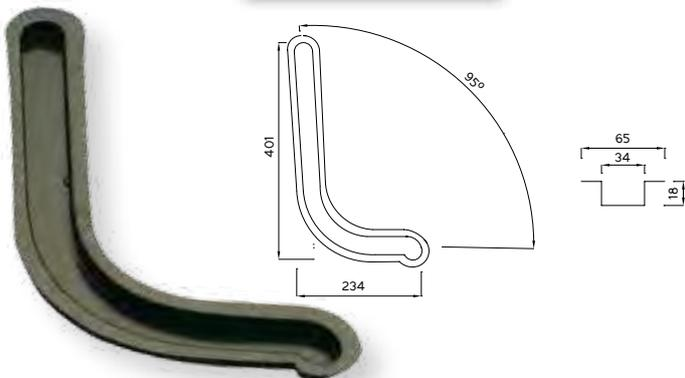

TW-2015

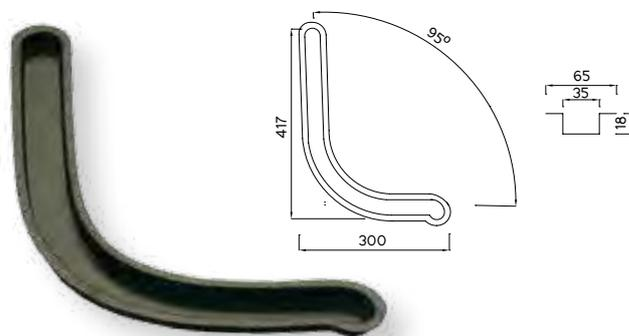

TW-0487

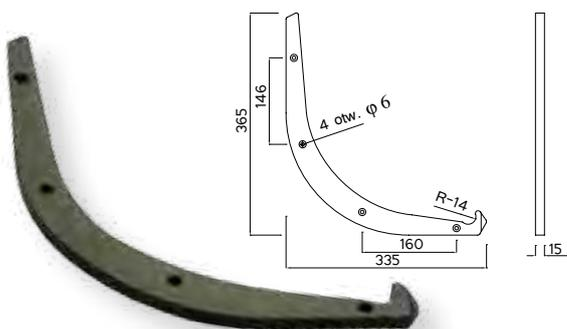

TW-0482

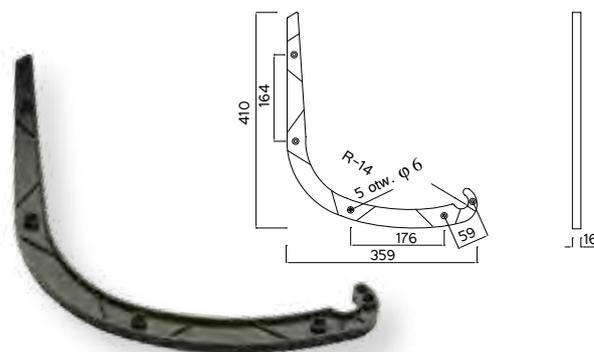

TW-0131

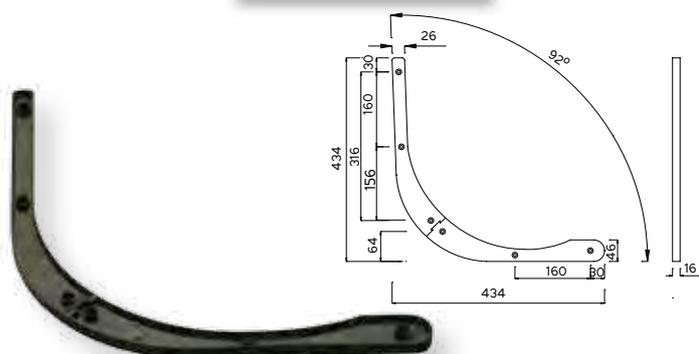

TW-2013

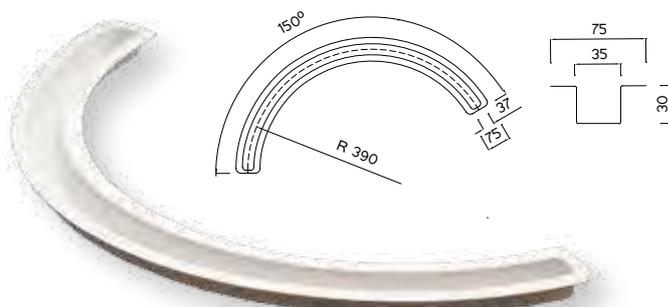



TW-2065

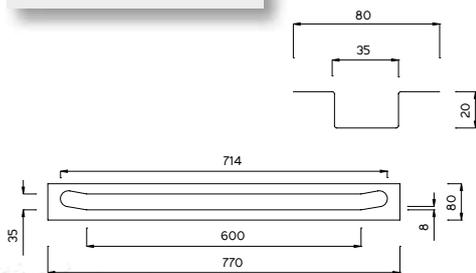

| Nr katalogowy | H | L |
|---------------|----|-----|
| TW-2054 | 70 | 280 |
| TW-2008 | 80 | 510 |
| TW-2009 | 80 | 790 |
| TW-2007 | 90 | 380 |

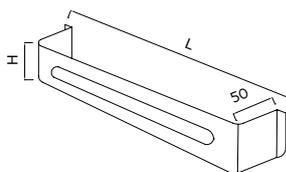

TW-2016

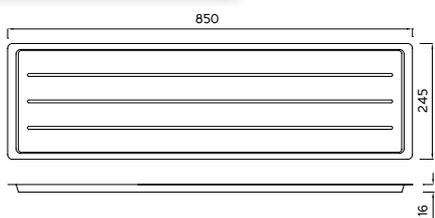

TW-2033

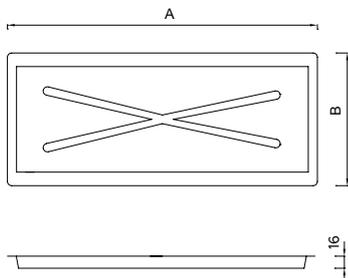
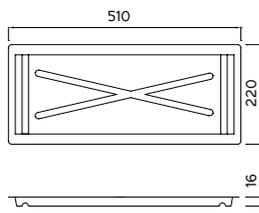

| Nr katalogowy | A | B |
|---------------|-----|-----|
| TW-2024 | 752 | 247 |
| TW-2023 | 748 | 247 |
| TW-2025 | 740 | 247 |
| TW-2026 | 760 | 247 |
| TW-2021 | 555 | 240 |
| TW-2022 | 560 | 240 |
| TW-2029 | 540 | 240 |
| TW-2020 | 450 | 240 |
| TW-2019 | 460 | 240 |
| TW-2028 | 440 | 240 |
| TW-2018 | 360 | 240 |
| TW-2063 | 644 | 240 |



| Nr katalogowy | A | B | C |
|---------------|-----|-----|----|
| TW-0144 | 505 | 192 | 17 |
| TW-0151 | 740 | 235 | 15 |

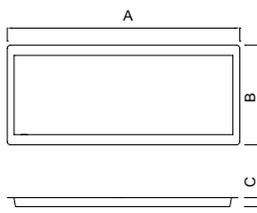

TW-2030

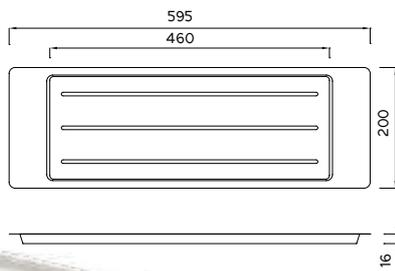

TW-2017

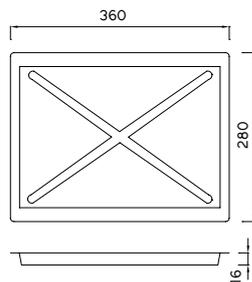



TW

TW-0122

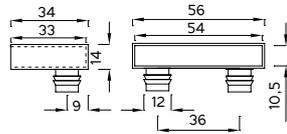

TW-0430

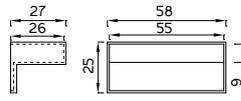

TW-0119

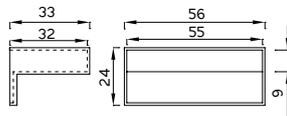

TW-0157

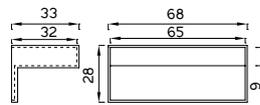

TW-0554

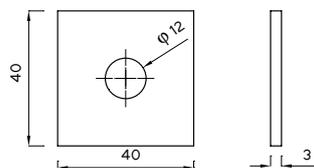

TW-0530

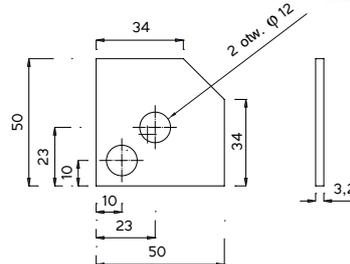

| Nr katalogowy | φ |
|---------------|-----------|
| TW-0471 | 50 |
| TW-7270 | 60 |

| Nr katalogowy | φ |
|---------------|-----------|
| TW-6302 | 50 |
| TW-6302.01 | 60 |

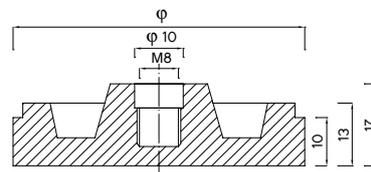
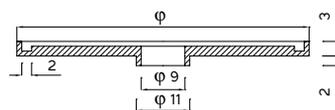

TW-0114

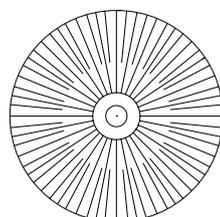
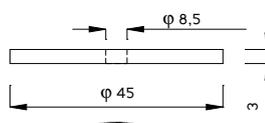

TW-0112

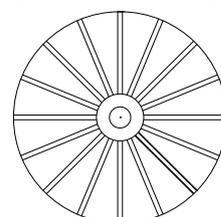
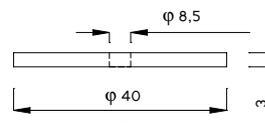

| Nr katalogowy | A | ϕ | B |
|---------------|----|--------|---|
| TW-0111 | 29 | 8,5 | 3 |
| TW-0111.01 | 29 | 10 | 3 |
| TW-0110 | 50 | 8,5 | 3 |
| TW-0110.01 | 50 | 10 | 3 |
| TW-0624 | 37 | 8 | 4 |
| TW-624.01 | 47 | 8 | 4 |
| TW-0109 | 60 | 8,5 | 3 |
| TW-0362 | 70 | 8,5 | 3 |

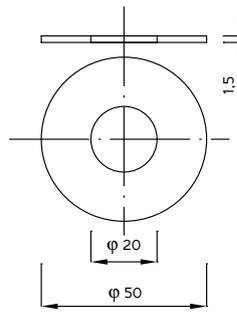
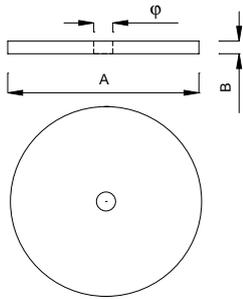

TW-0416



TW



| Nr katalogowy | H |
|---------------|----|
| TW-0369 | 7 |
| TW-0402 | 10 |

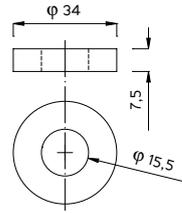
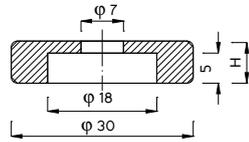

TW-0186



TW-0086

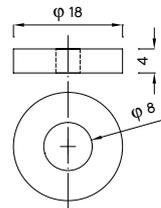
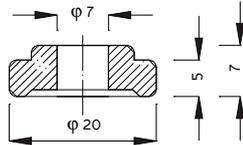

TW-0327



TW-0108

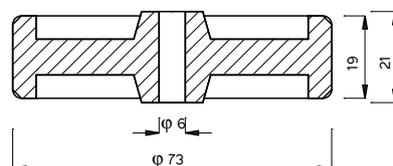
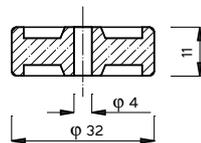

TW-0107



TW-0504

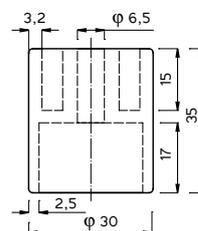
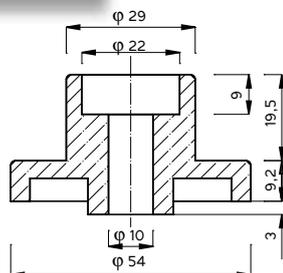

TW-0154





TW

TW-0155

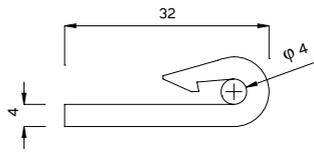

TW-0156

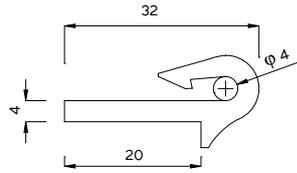

TW-7055

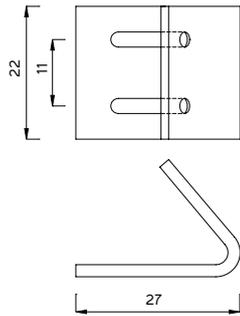

TW-0094

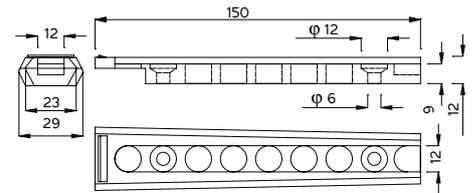

| Nr katalogowy | H |
|---------------|----|
| TW-0307 | 6 |
| TW-0095 | 10 |

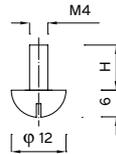

| Nr katalogowy | H |
|---------------|----|
| TW-0096 | 13 |
| TW-0097 | 17 |
| TW-0098 | 22 |
| TW-0099 | 32 |

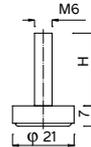

| Nr katalogowy | H |
|---------------|----|
| TW-7139 | 5 |
| TW-0101 | 10 |

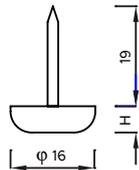

| Nr katalogowy | φ |
|---------------|----|
| TW-0165 | 25 |
| TW-0163 | 30 |

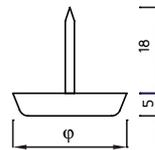

TW-0102

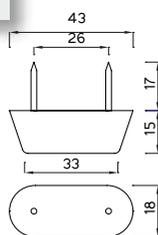

TW-0187

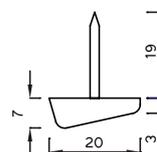



TW-0129

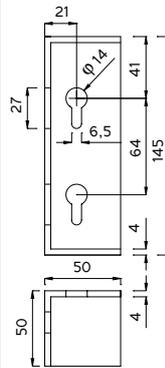
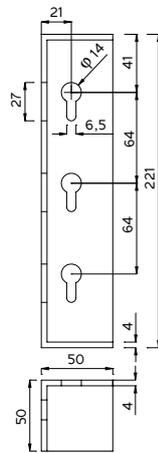

TW-0130



TW



TW-0079

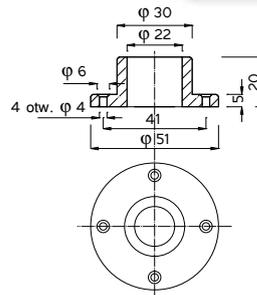
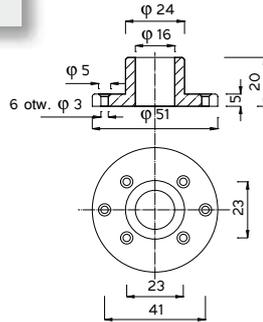

TW-0080



TW-0521

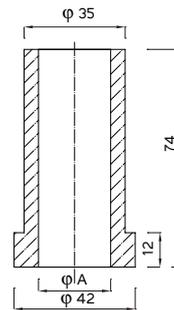
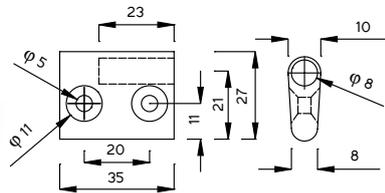

Nr katalogowy

A

TW-0078

16

TW-0076

22

TW-0077

25



TW-0344

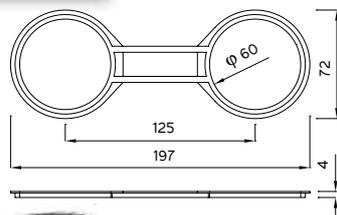

TW-0128

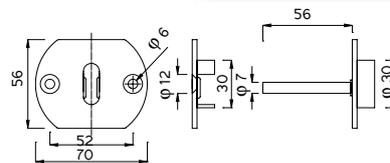

TW-0184

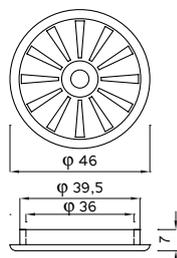

TW-0552

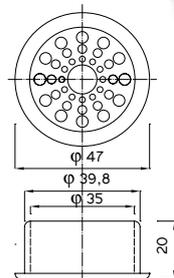

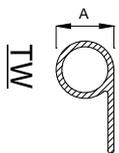

| Nr katalogowy | A | Nr katalogowy | A |
|---------------|----|---------------|----|
| TW-7003 | 4 | TW-7008 | 16 |
| TW-7101 | 5 | TW-7135 | 17 |
| TW-7004 | 8 | TW-7136 | 18 |
| TW-7005 | 10 | TW-7009 | 20 |
| TW-7006 | 12 | TW-7223 | 22 |
| TW-7007 | 14 | TW-7224 | 25 |



| Nr katalogowy | A | B |
|---------------|----|----|
| TW-7103 | 8 | 13 |
| TW-7102 | 13 | 21 |
| TW-7010 | 15 | 24 |

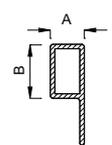

TW-7226

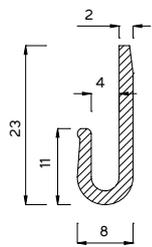

TW-7226.01

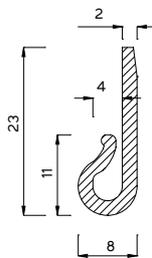

wężyki

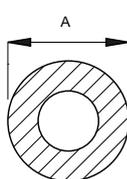

| Nr katalogowy | A |
|---------------|----|
| TW-7016 | 4 |
| TW-7020 | 5 |
| TW-7022 | 6 |
| TW-7312 | 8 |
| TW-7099 | 10 |
| TW-7100 | 16 |

TW-7022.01

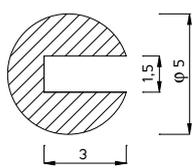

żyłki

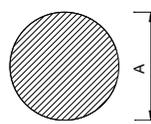

| Nr katalogowy | A |
|---------------|---|
| TW-7028 | 3 |
| TW-7018 | 4 |
| TW-7138 | 5 |
| TW-7163 | 7 |
| TW-7031 | 8 |

| Nr katalogowy | A |
|---------------|---|
| TW-7012 | 4 |
| TW-7013 | 5 |
| TW-7021 | 6 |
| TW-7021.01 | 8 |

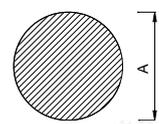

pręciki

TW-7473

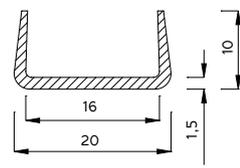

TW-7225

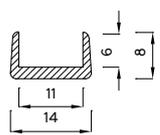

| Nr katalogowy | L | H |
|---------------|----|----|
| TW-7002 | 18 | 13 |
| TW-7907 | 16 | 16 |
| TW-7908 | 17 | 17 |

| Nr katalogowy | L | H |
|---------------|----|----|
| TW-7909 | 18 | 18 |
| TW-7910 | 20 | 20 |
| TW-7911 | 20 | 14 |

TW-7104

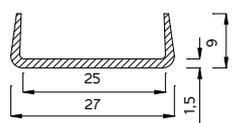
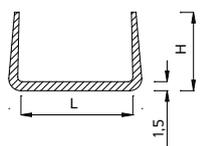

TW-7105

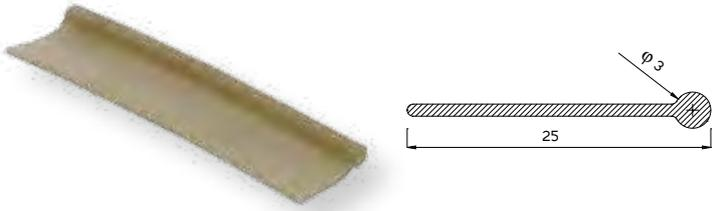

TW-7106

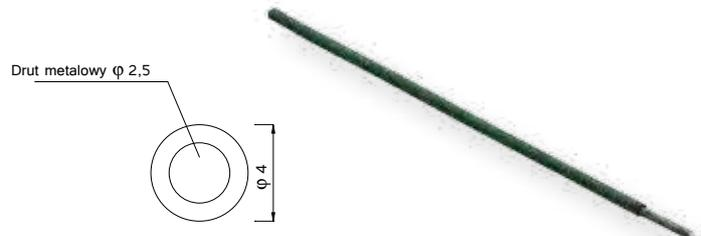

TW-7014

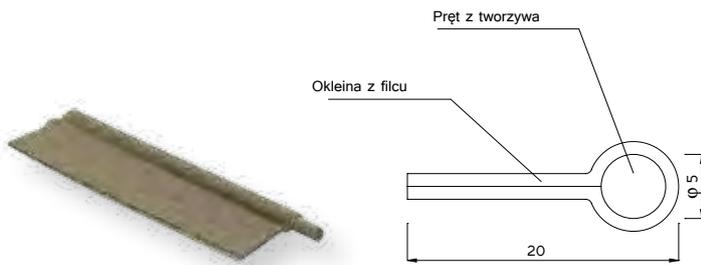

TW-7107



| Nr katalogowy | A | B |
|---------------|------|-----|
| TW-7108.02 | 11,5 | 3,2 |
| TW-7108 | 14,5 | 4,2 |
| TW-7108.01 | 30 | 10 |

TW-7109

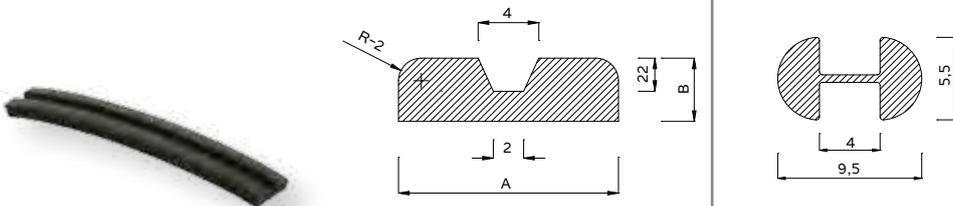

TW-7900

New



TW-7465



TW-7123



TW-7122

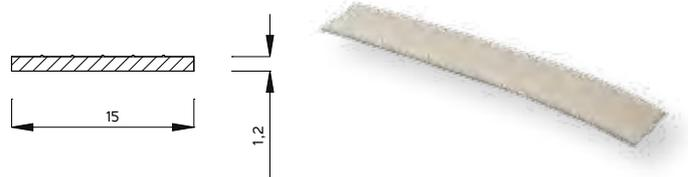



TW

TW-7466

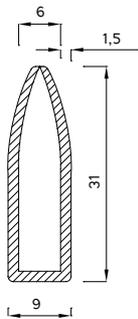

TW-7472

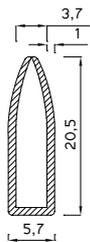

| Nr katalogowy Nowosc | A | B | X |
|-------------------------|----|----|-----|
| TW-7467 | 20 | 22 | 2 |
| ■ TW-7903 | 10 | 14 | 1,5 |

| Nr katalogowy Nowosc | A | B | Nr katalogowy Nowosc | A | B |
|-------------------------|----|-----|-------------------------|----|-----|
| TW-7471 | 28 | 2 | TW-7521 | 10 | 1 |
| TW-7468 | 25 | 1,5 | TW-7732 | 45 | 1,5 |
| TW-7469 | 16 | 2,5 | ■ TW-7906 | 30 | 2,5 |
| ■ TW-7904 | 20 | 2 | | | |
| ■ TW-7905 | 20 | 2,5 | | | |

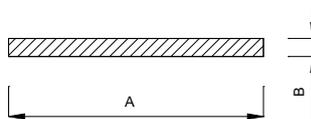
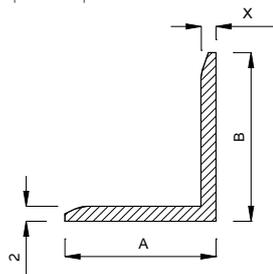

| Nr katalogowy Nowosc | A | B |
|-------------------------|----|---|
| TW-7676 | 10 | 7 |
| ■ TW-7676.01 | 7 | 6 |

TW-7470

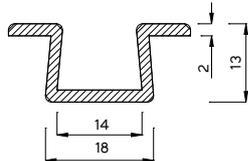
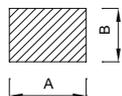

| Nr katalogowy | H | H-1 |
|---------------|----|-----|
| TW-7733 | 16 | 10 |
| TW-7734 | 10 | 4 |

TW-7011

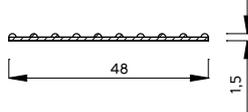
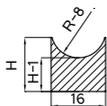

TW-7901

New

TW-7902

New

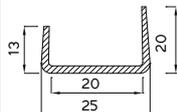
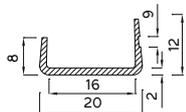

TW-7845

New

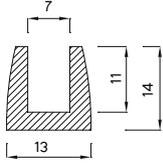

TW-7121

TW

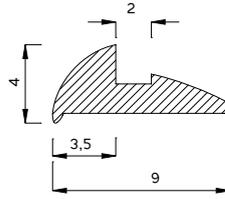

| Nr katalogowy | $\varnothing D$ |
|---------------|-----------------|
| TW-7110.01 | 5 |
| TW-7110 | 6 |

TW-7112

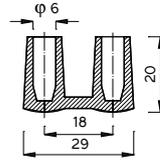
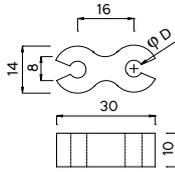

TW-7137

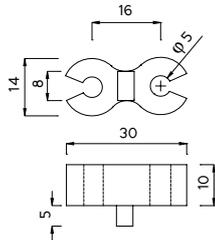

TW-7113

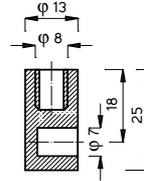

TW-7120

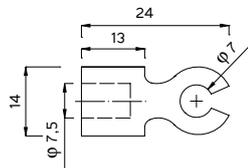

TW-7114

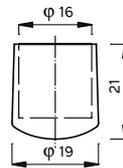

| Nr katalogowy | $\varnothing D$ |
|---------------|-----------------|
| TW-7115 | 7 |
| TW-7115.01 | 8 |

| Nr katalogowy | $\varnothing D$ |
|---------------|-----------------|
| TW-7116 | 4,5 |
| TW-7116.01 | 5,0 |
| TW-7116.02 | 5,5 |

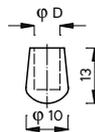
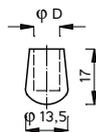



TWI

| Nr katalogowy | ϕD |
|---------------|----------|
| TW-7117 | 3 |
| TW-7117.01 | 4 |

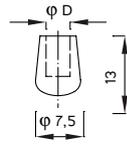

TW-7119

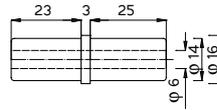

TW-7474

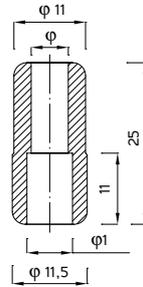
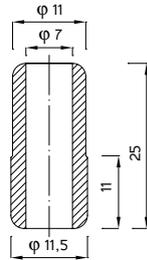

| Nr katalogowy | ϕ | $\phi 1$ |
|---------------|--------|----------|
| TW-7475 | 4,7 | 5,7 |
| TW-7475.01 | 5,7 | 7,0 |



| Nr katalogowy | ϕ | Nr katalogowy | ϕ |
|---------------|--------|---------------|--------|
| TW-9011 | 12 | TW-9013 | 37 |
| TW-9001 | 20 | TW-9004 | 40 |
| TW-9009 | 25 | TW-9010 | 45 |
| TW-9012 | 28 | TW-9005 | 50 |
| TW-9002 | 30 | TW-9006 | 60 |
| TW-9003 | 35 | TW-9007 | 70 |

FILC - kolor biały i szary. Istnieje możliwość wykonania podkładki filcowej wg dokumentacji klienta.

FELT – white or grey colour. It is also possible to additionally produce felt underlays on the base of the documentation provided by the customer.

FILZ – in weißer und in grauer Fräbe. Es besteht die Möglichkeit der Herstellung von Filzunterlagen aufgrund der Dokumentation des Kunden.

ВОЙЛОК – белого и серого цвета. Возможно изготовление войлочной прокладки по заказу и проекту клиента.

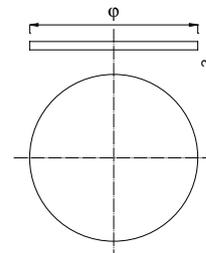

TW-7476

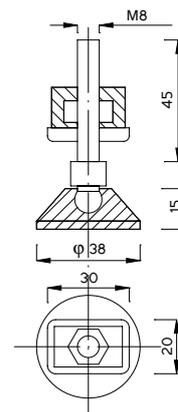

| Kod detalu | Str. | Pakowanie | Kod detalu | Str. | Pakowanie | Kod detalu | Str. | Pakowanie | Kod detalu | Str. | Pakowanie |
|---------------------|------|-------------|---------------------|------|-----------|---------------------------|------|-----------|---------------------|------|-----------|
| | | TW-M | TW-M 1102 | 11 | 168 szt. | TW-M 1195 | 15 | 90 szt. | TW-M 1159.01 | 22 | 44 kpl. |
| TW-M 1001 | 9 | 189 szt. | TW-M 1102.01 | 11 | 126 szt. | TW-M 1199 | 12 | 60 szt. | TW-M 1160 | 19 | 250 szt. |
| TW-M 1002 | 9 | 189 szt. | TW-M 1102.02 | 11 | 126 szt. | TW-M 1200 | 15 | 500 szt. | TW-M 1160.02 | 19 | 274 szt. |
| TW-M 1003 | 9 | 192 szt. | TW-M 1102.03 | 16 | 252 szt. | TW-M 1201.03 | 10 | 72 szt. | TW-M 1160.03 | 19 | 250 szt. |
| TW-M 1004 | 9 | 320 szt. | TW-M 1102.04 | 16 | 168 szt. | TW-M 1202 | 14 | 80 szt. | TW-M 1166 | 22 | 60 szt. |
| TW-M 1005 | 9 | 256 szt. | TW-M 1102.05 | 16 | 210 szt. | TW-M 1204 | 14 | 60 szt. | TW-M 1169 | 19 | 500 szt. |
| TW-M 1006 | 11 | 1024 szt. | TW-M 1112 | 10 | 108 szt. | TW-M 1204.02 | 14 | 120 szt. | TW-M 1179 | 21 | 180 szt. |
| TW-M 1007 | 11 | 704 szt. | TW-M 1113 | 10 | 144 szt. | TW-M 1204.03 | 14 | 100 szt. | TW-M 1182 | 21 | 126 szt. |
| TW-M 1008 | 11 | 512 szt. | TW-M 1114 | 9 | 108 szt. | TW-M 1204.04 | 14 | 100 szt. | TW-M 1184 | 22 | 98 szt. |
| TW-M 1009 | 11 | 384 szt. | TW-M 1115 | 9 | 144 szt. | TW-M 1205 | 16 | 336 szt. | TW-M 1193.02 | 22 | 160 szt. |
| TW-M 1009.02 | 9 | 384 szt. | TW-M 1121 | 10 | 80 szt. | TW-M 1207 | 14 | 50 szt. | TW-M 1196 | 21 | 90 szt. |
| TW-M 1010 | 11 | 144 szt. | TW-M 1121.01 | 10 | 100 szt. | TW-M 1208.01 | 14 | 52 szt. | TW-M 1205.01 | 22 | 336 szt. |
| TW-M 1011 | 11 | 108 szt. | TW-M 1121.02 | 10 | 100 szt. | TW-M 1211 | 11 | 280 szt. | TW-M 1207.01 | 22 | 50 szt. |
| TW-M 1011.01 | 11 | 108 szt. | TW-M 1124.01 | 16 | 63 szt. | TW-M 7508 | 16 | 1000 szt. | TW-M 7038.06 | 19 | 40 szt. |
| TW-M 1012 | 10 | 48 szt. | TW-M 1125.04 | 16 | 72 szt. | TW-M drewnopodobne | | | TW-M 7039.05 | 19 | 40 szt. |
| TW-M 1014 | 10 | 100 szt. | TW-M 1129 | 16 | 2200 szt. | TW-M 1011.02 | 18 | 108 szt. | | | |
| TW-M 1015 | 10 | 100 szt. | TW-M 1134 | 13 | 37 szt. | TW-M 1022 | 21 | 64 szt. | | | |
| TW-M 1015.02 | 15 | 46 szt. | TW-M 1135 | 12 | 80 szt. | TW-M 1025.01 | 18 | 150 szt. | | | |
| TW-M 1016 | 10 | 100 szt. | TW-M 1135.05 | 12 | 96 szt. | TW-M 1033 | 18 | 189 szt. | | | |
| TW-M 1018 | 12 | 96 szt. | TW-M 1137 | 10 | 125 szt. | TW-M 1034 | 20 | 64 szt. | | | |
| TW-M 1019 | 9 | 108 szt. | TW-M 1138 | 14 | 54 kpl | TW-M 1035 | 20 | 96 szt. | | | |
| TW-M 1019.02 | 9 | 150 szt. | TW-M 1138.09 | 14 | 54 kpl | TW-M 1040 | 21 | 64 szt. | | | |
| TW-M 1020 | 9 | 150 szt. | TW-M 1139 | 12 | 144 szt. | TW-M 1041 | 19 | 512 szt. | | | |
| TW-M 1020.02 | 9 | 80 szt. | TW-M 1139.06 | 12 | 144 szt. | TW-M 1041.01 | 19 | 384 szt. | | | |
| TW-M 1021 | 12 | 64 szt. | TW-M 1142 | 10 | 64 szt. | TW-M 1041.02 | 19 | 640 szt. | | | |
| TW-M 1023 | 9 | 320 szt. | TW-M 1142.01 | 10 | 80 szt. | TW-M 1042 | 19 | 320 szt. | | | |
| TW-M 1023.01 | 11 | 320 szt. | TW-M 1143.01 | 15 | 200 szt. | TW-M 1042.01 | 19 | 320 szt. | | | |
| TW-M 1025 | 11 | 150 szt. | TW-M 1144 | 13 | 76 szt. | TW-M 1048 | 18 | 80 szt. | | | |
| TW-M 1026 | 11 | 200 szt. | TW-M 1145 | 13 | 90 szt. | TW-M 1050 | 20 | 96 szt. | | | |
| TW-M 1027 | 10 | 80 szt. | TW-M 1146 | 9 | 168 szt. | TW-M 1052 | 20 | 96 szt. | | | |
| TW-M 1030 | 16 | 840 szt. | TW-M 1146.01 | 9 | 126 szt. | TW-M 1053.02 | 20 | 64 szt. | | | |
| TW-M 1031 | 11 | 640 szt. | TW-M 1146.02 | 9 | 84 szt. | TW-M 1053.03 | 20 | 80 szt. | | | |
| TW-M 1036 | 9 | 192 szt. | TW-M 1148 | 11 | 180 szt. | TW-M 1055 | 22 | 74 szt. | | | |
| TW-M 1037 | 10 | 150 szt. | TW-M 1151 | 9 | 256 szt. | TW-M 1055.03 | 22 | 37 szt. | | | |
| TW-M 1038.01 | 11 | 320 szt. | TW-M 1153 | 13 | 275 szt. | TW-M 1055.04 | 22 | 37 szt. | | | |
| TW-M 1039 | 13 | 74 szt. | TW-M 1153.02 | 13 | 225 szt. | TW-M 1056 | 20 | 64 szt. | | | |
| TW-M 1044 | 13 | 37 szt. | TW-M 1154.01 | 15 | 500 szt. | TW-M 1056.02 | 20 | 80 szt. | | | |
| TW-M 1051 | 9 | 80 szt. | TW-M 1158 | 10 | 125 szt. | TW-M 1090.01 | 18 | 125 szt. | | | |
| TW-M 1057 | 16 | 1000 szt. | TW-M 1159 | 14 | 44 kpl | TW-M 1097 | 20 | 96 szt. | | | |
| TW-M 1058 | 12 | 500 szt. | TW-M 1160.01 | 15 | 250 szt. | TW-M 1097.01 | 20 | 96 szt. | | | |
| TW-M 1058.01 | 12 | 400 szt. | TW-M 1161 | 16 | 224 szt. | TW-M 1103 | 18 | 144 szt. | | | |
| TW-M 1059 | 10 | 48 szt. | TW-M 1162 | 11 | 100 szt. | TW-M 1104 | 18 | 108 szt. | | | |
| TW-M 1060 | 12 | 64 szt. | TW-M 1162.01 | 11 | 100 szt. | TW-M 1105 | 18 | 126 szt. | | | |
| TW-M 1060.01 | 12 | 64 szt. | TW-M 1162.02 | 11 | 75 szt. | TW-M 1107 | 18 | 320 szt. | | | |
| TW-M 1060.03 | 12 | 96 szt. | TW-M 1163 | 13 | 80 szt. | TW-M 1108 | 18 | 320 szt. | | | |
| TW-M 1060.04 | 12 | 80 szt. | TW-M 1163.01 | 13 | 64 szt. | TW-M 1109 | 18 | 256 szt. | | | |
| TW-M 1060.05 | 12 | 54 szt. | TW-M 1164 | 13 | 60 szt. | TW-M 1110 | 18 | 192 szt. | | | |
| TW-M 1060.06 | 12 | 80 szt. | TW-M 1165 | 9 | 126 szt. | TW-M 1111 | 18 | 189 szt. | | | |
| TW-M 1061 | 10 | 100 szt. | TW-M 1167 | 16 | 600 szt. | TW-M 1116 | 18 | 100 szt. | | | |
| TW-M 1062 | 9 | 135 szt. | TW-M 1171 | 13 | 98 szt. | TW-M 1117 | 18 | 100 szt. | | | |
| TW-M 1062.01 | 9 | 135 szt. | TW-M 1172 | 13 | 180 szt. | TW-M 1118 | 18 | 100 szt. | | | |
| TW-M 1063 | 9 | 135 szt. | TW-M 1173 | 15 | 500 szt. | TW-M 1123 | 18 | 96 szt. | | | |
| TW-M 1063.05 | 9 | 135 szt. | TW-M 1177.02 | 11 | 640 szt. | TW-M 1125 | 19 | 72 szt. | | | |
| TW-M 1075 | 9 | 108 szt. | TW-M 1178 | 15 | 78 szt. | TW-M 1131 | 19 | 63 szt. | | | |
| TW-M 1075.02 | 9 | 84 szt. | TW-M 1181 | 13 | 144 szt. | TW-M 1138.02 | 22 | 108 kpl | | | |
| TW-M 1076 | 9 | 135 szt. | TW-M 1181.01 | 13 | 144 szt. | TW-M 1139.03 | 21 | 108 szt. | | | |
| TW-M 1091 | 10 | 192 szt. | TW-M 1183 | 9 | 189 szt. | TW-M 1145.01 | 22 | 90 szt. | | | |
| TW-M 1096 | 10 | 100 szt. | TW-M 1183.02 | 9 | 112 szt. | TW-M 1148.01 | 18 | 180 szt. | | | |
| TW-M 1096.02 | 10 | 100 szt. | TW-M 1186 | 9 | 150 szt. | TW-M 1149 | 22 | 126 szt. | | | |
| TW-M 1096.03 | 10 | 100 szt. | TW-M 1192 | 15 | 324 szt. | TW-M 1150 | 21 | 76 szt. | | | |
| TW-M 1098 | 10 | 126 szt. | TW-M 1193.01 | 14 | 160 szt. | TW-M 1151.01 | 18 | 256 szt. | | | |
| TW-M 1099 | 9 | 126 szt. | TW-M 1194 | 13 | 90 szt. | TW-M 1153.01 | 21 | 275 szt. | | | |

INDEX

| Kod detalu | Str. | Kod detalu | Str. | Kod detalu | Str. | Kod detalu | Str. | Kod detalu | Str. | Kod detalu | Str. | Kod detalu | Str. | Kod detalu | Str. |
|------------|------|------------|------|------------|------|------------|------|------------|------|------------|------|-------------|------|-------------|------|
| AL | | AL 4084 | 28 | AL 7433 | 29 | ST 3008.02 | 54 | ST 3052.01 | 43 | ST 3153.03 | 44 | ST 3340 | 43 | ST 3510 | 44 |
| AL 4001 | 24 | AL 4091 | 33 | AL 7434 | 29 | ST 3009.01 | 46 | ST 3053 | 44 | ST 3154 | 44 | ST 3340.01 | 43 | ST 3512 | 57 |
| AL 4002 | 24 | AL 4093 | 33 | AL 7435 | 30 | ST 3009.03 | 46 | ST 3054 | 54 | ST 3155 | 67 | ST 3341 | 42 | ST 3514 | 52 |
| AL 4003 | 24 | AL 4098 | 33 | AL 7436 | 30 | ST 3010 | 44 | ST 3055 | 43 | ST 3161 | 45 | ST 3351 | 41 | ST 3517 | 61 |
| AL 4004 | 26 | AL 4098.01 | 33 | AL 7437 | 30 | ST 3010.01 | 44 | ST 3056 | 45 | ST 3163 | 41 | ST 3358 | 50 | ST 3518 | 51 |
| AL 4005 | 26 | AL 4104 | 26 | AL 7438 | 30 | ST 3010.03 | 44 | ST 3056.01 | 43 | ST 3164 | 41 | ST 3358.01 | 50 | ST 3522 | 52 |
| AL 4006 | 26 | AL 4108 | 35 | AL 7439 | 30 | ST 3010.05 | 44 | ST 3057 | 43 | ST 3165 | 49 | ST 3382 | 52 | ST 3529 | 50 |
| AL 4007 | 28 | AL 4110 | 30 | AL 7440 | 30 | ST 3011 | 41 | ST 3058 | 43 | ST 3165.07 | 49 | ST 3383 | 52 | ST 3529.01 | 50 |
| AL 4008 | 28 | AL 4112 | 24 | AL 7441 | 30 | ST 3011.01 | 41 | ST 3061 | 53 | ST 3167 | 44 | ST 3384 | 57 | ST 3536 | 51 |
| AL 4009 | 27 | AL 4113 | 35 | AL 7448 | 31 | ST 3012 | 44 | ST 3063 | 43 | ST 3168 | 43 | ST 3396 | 52 | ST 3539 | 43 |
| AL 4010 | 27 | AL 4120 | 26 | AL 7449 | 32 | ST 3013 | 43 | ST 3068 | 36 | ST 3170 | 57 | ST 3398 | 51 | ST 3547 | 55 |
| AL 4011 | 27 | AL 4121 | 27 | AL 7449.01 | 32 | ST 3014 | 43 | ST 3068.01 | 36 | ST 3175 | 56 | ST 3401 | 49 | ST 3547.01 | 55 |
| AL 4012 | 27 | AL 4123 | 28 | AL 7449.02 | 32 | ST 3015 | 41 | ST 3073 | 51 | ST 3175.02 | 56 | ST 3401.01 | 49 | ST 3548 | 61 |
| AL 4012.03 | 27 | AL 4126 | 27 | AL 7449.03 | 32 | ST 3016 | 46 | ST 3083 | 42 | ST 3188 | 41 | ST 3401.02 | 49 | ST 3549 | 55 |
| AL 4012.04 | 27 | AL 4127 | 27 | AL 7449.04 | 32 | ST 3017 | 41 | ST 3084 | 43 | ST 3188.01 | 41 | ST 3401.03 | 49 | ST 3566 | 61 |
| AL 4012.05 | 27 | AL 4127.01 | 27 | AL 7449.05 | 32 | ST 3018 | 41 | ST 3085 | 54 | ST 3188.02 | 41 | ST 3403 | 46 | ST 3570 | 52 |
| AL 4013 | 24 | AL 4135 | 25 | AL 7449.06 | 32 | ST 3018.01 | 41 | ST 3086 | 54 | ST 3188.03 | 41 | ST 3404 | 61 | ST 3571 | 48 |
| AL 4013.01 | 24 | AL 4136 | 35 | AL 7453.01 | 31 | ST 3018.02 | 41 | ST 3087 | 54 | ST 3188.04 | 41 | ST 3408 | 49 | ST 3575 | 48 |
| AL 4014 | 26 | AL 4138 | 27 | AL 7454 | 28 | ST 3020 | 54 | ST 3088 | 43 | ST 3195 | 43 | ST 3409 | 51 | ST 3576 | 46 |
| AL 4015 | 24 | AL 4156 | 35 | AL 7454.01 | 28 | ST 3020.01 | 54 | ST 3089 | 42 | ST 3198 | 54 | ST 3410.15 | 59 | ST 3577 | 57 |
| AL 4017 | 25 | AL 4164 | 30 | AL 7455 | 31 | ST 3020.05 | 54 | ST 3091 | 45 | ST 3198.01 | 54 | ST 3414 | 43 | ST 3578 | 55 |
| AL 4017.01 | 25 | AL 4165 | 35 | AL 7455.01 | 31 | ST 3020.06 | 54 | ST 3093 | 42 | ST 3200 | 56 | ST 3415 | 45 | ST 3579 | 55 |
| AL 4018 | 25 | AL 4166 | 27 | AL 7456.01 | 26 | ST 3021 | 45 | ST 3094 | 42 | ST 3200.01 | 56 | ST 3416 | 54 | ST 3580 | 55 |
| AL 4019 | 25 | AL 4166.01 | 27 | AL 7553 | 32 | ST 3022 | 61 | ST 3095 | 44 | ST 3201 | 52 | ST 3417 | 50 | ST 3581 | 64 |
| AL 4020 | 25 | AL 4166.05 | 27 | AL 7608 | 29 | ST 3023 | 53 | ST 3097 | 41 | ST 3201.01 | 52 | ST 3418 | 41 | ST 3582 | 48 |
| AL 4021 | 27 | AL 4166.06 | 27 | AL 7609 | 32 | ST 3023.02 | 53 | ST 3102 | 43 | ST 3201.03 | 52 | ST 3421 | 48 | ST 3584 | 55 |
| AL 4022 | 27 | AL 4166.07 | 27 | AL 7610 | 32 | ST 3023.05 | 53 | ST 3103 | 43 | ST 3203 | 57 | ST 3422 | 49 | ST 3585 | 55 |
| AL 4024 | 34 | AL 4166.08 | 27 | AL 7618 | 32 | ST 3025 | 43 | ST 3105 | 43 | ST 3203.01 | 57 | ST 3424 | 45 | ST 3586 | 55 |
| AL 4024.01 | 34 | AL 4166.09 | 27 | AL 7630.01 | 33 | ST 3025.01 | 43 | ST 3108 | 54 | ST 3203.02 | 57 | ST 3428 | 59 | ST 3599 | 62 |
| AL 4025 | 24 | AL 4166.10 | 27 | AL 7661 | 32 | ST 3025.02 | 43 | ST 3113 | 52 | ST 3205 | 42 | ST 3429 | 42 | ST 3599.04 | 62 |
| AL 4026 | 26 | AL 4171 | 35 | AL 7737.01 | 33 | ST 3026 | 43 | ST 3113.01 | 52 | ST 3212 | 42 | ST 3434 | 63 | ST 3604 | 65 |
| AL 4027 | 26 | AL 4172 | 35 | AL 7746.02 | 33 | ST 3026.01 | 43 | ST 3113.02 | 52 | ST 3213 | 51 | ST 3434.15 | 56 | ST 3610 | 48 |
| AL 4029 | 25 | AL 4175 | 35 | AL 7811.03 | 31 | ST 3027 | 43 | ST 3114 | 43 | ST 3214 | 42 | ST 3441 | 57 | ST 3614 | 58 |
| AL 4032 | 24 | AL 4176 | 35 | AL 7834 | 31 | ST 3028 | 43 | ST 3115 | 56 | ST 3215 | 42 | ST 3442 | 57 | ST 3619 | 58 |
| AL 4033 | 34 | AL 4177 | 24 | AL 7834.01 | 31 | ST 3028.01 | 43 | ST 3116 | 56 | ST 3216 | 42 | ST 3444 | 59 | ST 3621 | 62 |
| AL 4035 | 25 | AL 4178 | 35 | DR | | ST 3029 | 43 | ST 3120 | 45 | ST 3217 | 44 | ST 3446 | 59 | ST 3624 | 56 |
| AL 4038 | 27 | AL 4178.01 | 35 | DR 5001 | 38 | ST 3029.01 | 43 | ST 3120.01 | 45 | ST 3218 | 44 | ST 3448 | 63 | ST 3626 | 58 |
| AL 4040 | 25 | AL 4185 | 26 | DR 5001.01 | 38 | ST 3030 | 43 | ST 3121 | 45 | ST 3219 | 44 | ST 3452 | 42 | ST 3628 | 64 |
| AL 4041 | 27 | AL 4192 | 34 | DR 5001.02 | 38 | ST 3031 | 43 | ST 3121.01 | 45 | ST 3220 | 42 | ST 3456 | 59 | ST 3633 | 48 |
| AL 4045 | 27 | AL 4198 | 24 | DR 5002 | 38 | ST 3032 | 43 | ST 3123 | 52 | ST 3223 | 52 | ST 3456.01 | 59 | ST 3634 | 49 |
| AL 4046 | 27 | AL 4204 | 28 | DR 5002.03 | 38 | ST 3033 | 43 | ST 3123.02 | 52 | ST 3224 | 52 | ST 3456.02 | 59 | ST 3635 | 58 |
| AL 4057 | 35 | AL 4210 | 33 | DR 5003 | 38 | ST 3034 | 43 | ST 3124 | 54 | ST 3226 | 41 | ST 3456.03 | 59 | ST 3652 | 58 |
| AL 4060 | 25 | AL 4214 | 34 | DR 5003.02 | 38 | ST 3035 | 43 | ST 3127 | 67 | ST 3232 | 52 | ST 3457 | 51 | ST 3663 | 64 |
| AL 4061 | 34 | AL 4215 | 28 | DR 5004 | 38 | ST 3035.01 | 43 | ST 3131 | 41 | ST 3233 | 52 | ST 3464 | 52 | ST 3669 | 60 |
| AL 4062 | 27 | AL 4215.01 | 28 | DR 5005 | 38 | ST 3036 | 43 | ST 3132 | 54 | ST 3255 | 43 | ST 3466 | 45 | ST 3674.02 | 47 |
| AL 4065 | 28 | AL 4230 | 33 | DR 5010 | 39 | ST 3037 | 43 | ST 3134 | 41 | ST 3267 | 54 | ST 3471 | 43 | ST 3674.021 | 47 |
| AL 4066 | 30 | AL 4233 | 24 | DR 5015 | 38 | ST 3037.01 | 43 | ST 3137.01 | 43 | ST 3284 | 52 | ST 3471.01 | 43 | ST 3689.01 | 65 |
| AL 4067 | 30 | AL 4234 | 34 | DR 5016 | 39 | ST 3038 | 43 | ST 3138 | 45 | ST 3284.01 | 52 | ST 3472 | 54 | ST 3692.01 | 47 |
| AL 4067.01 | 30 | AL 4234.01 | 34 | DR 5046 | 39 | ST 3039 | 43 | ST 3142 | 42 | ST 3287 | 57 | ST 3473 | 67 | ST 3703 | 65 |
| AL 4068 | 30 | AL 4241 | 32 | DR 5047 | 38 | ST 3040 | 43 | ST 3143 | 43 | ST 3291 | 52 | ST 3474 | 60 | ST 3705 | 47 |
| AL 4069 | 30 | AL 4246 | 34 | DR 5048 | 38 | ST 3041 | 43 | ST 3144 | 54 | ST 3294 | 54 | ST 3479 | 56 | ST 3706 | 53 |
| AL 4069.01 | 30 | AL 4249 | 33 | DR 7539 | 39 | ST 3042 | 43 | ST 3145 | 54 | ST 3295.01 | 44 | ST 3480 | 54 | ST 3707 | 53 |
| AL 4070 | 30 | AL 4258 | 31 | DR 7611 | 39 | ST 3043 | 43 | ST 3145.01 | 54 | ST 3304 | 51 | ST 3482 | 67 | ST 3715 | 60 |
| AL 4071 | 30 | AL 7293 | 29 | DR 7612 | 39 | ST 3044 | 43 | ST 3149 | 54 | ST 3305 | 51 | ST 3483 | 48 | ST 3717 | 47 |
| AL 4072 | 30 | AL 7293.01 | 29 | ST | | ST 3045 | 43 | ST 3149.01 | 54 | ST 3311 | 44 | ST 3484 | 43 | ST 3717.01 | 47 |
| AL 4073 | 30 | AL 7293.02 | 29 | ST 3001 | 44 | ST 3046 | 43 | ST 3149.03 | 54 | ST 3319 | 52 | ST 3486 | 43 | ST 3721.01 | 67 |
| AL 4075 | 33 | AL 7322 | 29 | ST 3003 | 54 | ST 3047 | 43 | ST 3150 | 56 | ST 3320.02 | 43 | ST 3486.01 | 43 | ST 3724 | 58 |
| AL 4076 | 33 | AL 7323 | 29 | ST 3004 | 54 | ST 3048 | 43 | ST 3150.02 | 56 | ST 3320.03 | 43 | ST 3494 | 59 | ST 3727 | 53 |
| AL 4077 | 33 | AL 7324 | 29 | ST 3005 | 54 | ST 3049 | 43 | ST 3151 | 43 | ST 3321 | 54 | ST 3501 | 46 | ST 3728 | 62 |
| AL 4077.01 | 33 | AL 7430 | 31 | ST 3006 | 54 | ST 3050 | 43 | ST 3152 | 44 | ST 3329 | 41 | ST 3502.011 | 47 | ST 3729 | 65 |
| AL 4080 | 34 | AL 7431 | 32 | ST 3007 | 54 | ST 3051 | 43 | ST 3152.01 | 44 | ST 3331 | 60 | ST 3503 | 42 | ST 3730 | 63 |
| AL 4081.01 | 34 | AL 7432 | 29 | ST 3008 | 54 | ST 3052 | 43 | ST 3153 | 44 | ST 3336 | 50 | ST 3505 | 49 | ST 3731 | 60 |

| Kod detalu | Str. | Kod detalu | Str. | Pakowanie | Kod detalu | Str. | Pakowanie | Kod detalu | Str. | Pakowanie |
|-------------|------|------------|------|-----------|------------|------|-----------|------------|------|-----------|
| ST 3732 | 60 | TW | | | TW 0083 | 78 | 1000 szt. | TW 0160 | 77 | 500 szt. |
| ST 3733 | 58 | TW 0001 | 72 | 100 szt. | TW 0085 | 83 | 1000 szt. | TW 0161 | 77 | 800 szt. |
| ST 3734 | 53 | TW 0003 | 72 | 100 szt. | TW 0086 | 87 | 1000 szt. | TW 0162 | 70 | 275 szt. |
| ST 6153 | 66 | TW 0006 | 72 | 100 szt. | TW 0087 | 83 | 1000 szt. | TW 0163 | 88 | 1000 szt. |
| ST 6155 | 66 | TW 0009 | 72 | 100 szt. | TW 0089 | 83 | 1000 szt. | TW 0165 | 88 | 1000 szt. |
| ST 6162 | 66 | TW 0012 | 72 | 100 szt. | TW 0089.01 | 83 | 1000 szt. | TW 0166 | 78 | 400 szt. |
| ST 6162.01 | 66 | TW 0013 | 72 | 168 szt. | TW 0091 | 83 | 1000 szt. | TW 0168 | 72 | 144 szt. |
| ST 6162.02 | 66 | TW 0014 | 72 | 189 szt. | TW 0092 | 83 | 1000 szt. | TW 0168.01 | 72 | 144 szt. |
| ST 6164 | 66 | TW 0014.01 | 72 | 189 szt. | TW 0093 | 83 | 1000 szt. | TW 0168.05 | 72 | 144 szt. |
| ST 6168 | 66 | TW 0015 | 72 | 192 szt. | TW 0094 | 88 | 500 szt. | TW 0169 | 72 | 108 szt. |
| ST 7172 | 43 | TW 0016 | 72 | 320 szt. | TW 0095 | 88 | 1000 szt. | TW 0171 | 73 | 200 szt. |
| ST 7228 | 61 | TW 0016.05 | 77 | 320 szt. | TW 0096 | 88 | 1000 szt. | TW 0172 | 73 | 200 szt. |
| ST 7229 | 61 | TW 0017 | 72 | 256 szt. | TW 0097 | 88 | 1000 szt. | TW 0173 | 82 | 1000 szt. |
| ST 7238 | 67 | TW 0018 | 72 | 150 szt. | TW 0098 | 88 | 1000 szt. | TW 0174 | 82 | 1000 szt. |
| ST 7268.01 | 67 | TW 0023 | 72 | 150 szt. | TW 0099 | 88 | 1000 szt. | TW 0175 | 81 | 1000 szt. |
| ST 7280 | 46 | TW 0024 | 72 | 200 szt. | TW 0101 | 88 | 1000 szt. | TW 0176 | 76 | 500 szt. |
| ST 7288 | 51 | TW 0027 | 75 | 250 szt. | TW 0102 | 88 | 1000 szt. | TW 0177 | 73 | 100 szt. |
| ST 7318 | 50 | TW 0028 | 75 | 300 szt. | TW 0103 | 79 | 1000 szt. | TW 0178 | 73 | 100 szt. |
| ST 7443 | 51 | TW 0029 | 75 | 300 szt. | TW 0104 | 81 | 1000 szt. | TW 0179 | 82 | 1000 szt. |
| ST 7443 | 51 | TW 0030 | 75 | 300 szt. | TW 0105 | 81 | 1000 szt. | TW 0180 | 82 | 1000 szt. |
| ST 7457 | 50 | TW 0032 | 75 | 250 szt. | TW 0106 | 80 | 1000 szt. | TW 0181 | 82 | 250 szt. |
| ST 7524 | 48 | TW 0033 | 78 | 300 szt. | TW 0107 | 87 | 400 szt. | TW 0182 | 82 | 250 szt. |
| ST 7526 | 66 | TW 0036 | 75 | 250 szt. | TW 0108 | 87 | 1000 szt. | TW 0183 | 82 | 1000 szt. |
| ST 7542 | 66 | TW 0036.04 | 75 | 512 szt. | TW 0109 | 87 | 1000 szt. | TW 0184 | 89 | 1000 szt. |
| ST 7607 | 49 | TW 0037 | 75 | 250 szt. | TW 0110 | 87 | 1000 szt. | TW 0185 | 74 | 200 szt. |
| ST 7633 | 46 | TW 0039 | 77 | 800 szt. | TW 0110.01 | 87 | 1000 szt. | TW 0186 | 87 | 1000 szt. |
| ST 7664 | 56 | TW 0040 | 76 | 500 szt. | TW 0111 | 87 | 1000 szt. | TW 0187 | 88 | 1000 szt. |
| ST 7664.01 | 56 | TW 0042 | 77 | 600 szt. | TW 0111.01 | 87 | 1000 szt. | TW 0188 | 80 | 1000 szt. |
| ST 7667 | 56 | TW 0043 | 76 | 500 szt. | TW 0112 | 86 | 1000 szt. | TW 0189 | 79 | 1000 szt. |
| ST 7668 | 56 | TW 0044 | 77 | 400 szt. | TW 0114 | 86 | 1000 szt. | TW 0190 | 83 | 1000 szt. |
| ST 7682 | 58 | TW 0046 | 76 | 300 szt. | TW 0117 | 81 | 1000 szt. | TW 0192 | 77 | 300 szt. |
| ST 7688 | 53 | TW 0047 | 76 | 500 szt. | TW 0118 | 81 | 1000 szt. | TW 0192.03 | 72 | 384 szt. |
| ST 7712 | 45 | TW 0048 | 76 | 500 szt. | TW 0119 | 86 | 1000 szt. | TW 0193 | 76 | 300 szt. |
| ST 7712.01 | 45 | TW 0049 | 76 | 800 szt. | TW 0122 | 86 | 1000 szt. | TW 0194 | 72 | 100 szt. |
| ST 7713 | 47 | TW 0050 | 76 | 800 szt. | TW 0125 | 83 | 1000 szt. | TW 0195 | 72 | 100 szt. |
| ST 7723 | 67 | TW 0051 | 76 | 1000 szt. | TW 0126 | 78 | 1000 szt. | TW 0196 | 74 | 200 szt. |
| ST 7791.021 | 53 | TW 0052 | 76 | 1000 szt. | TW 0127 | 81 | 300 szt. | TW 0197 | 79 | 1000 szt. |
| | | TW 0053 | 74 | 100 szt. | TW 0128 | 89 | 500 szt. | TW 0198 | 79 | 1000 szt. |
| | | TW 0055 | 74 | 100 szt. | TW 0129 | 89 | 100 szt. | TW 0199 | 80 | 1000 szt. |
| | | TW 0056 | 82 | 500 szt. | TW 0130 | 89 | 100 szt. | TW 0200 | 80 | 1000 szt. |
| | | TW 0057 | 82 | 800 szt. | TW 0131 | 84 | 50 kpl | TW 0201 | 69 | 96 szt. |
| | | TW 0058 | 82 | 1000 szt. | TW 0132 | 84 | 10 kpl | TW 0203 | 74 | 70 szt. |
| | | TW 0059.01 | 82 | 1000 szt. | TW 0133 | 84 | 10 kpl | TW 0229 | 80 | 1000 szt. |
| | | TW 0060 | 78 | 1000 szt. | TW 0134 | 84 | 10 kpl | TW 0233 | 83 | 1000 szt. |
| | | TW 0061 | 83 | 1000 szt. | TW 0135 | 84 | 10 kpl | TW 0307 | 88 | 1000 szt. |
| | | TW 0062 | 77 | 800 szt. | TW 0136 | 84 | 10 kpl | TW 0312 | 82 | 250 szt. |
| | | TW 0063 | 80 | 1000 szt. | TW 0137 | 84 | 10 kpl | TW 0313 | 82 | 250 szt. |
| | | TW 0064 | 80 | 1000 szt. | TW 0138 | 84 | 10 kpl | TW 0314 | 82 | 250 szt. |
| | | TW 0065 | 80 | 1000 szt. | TW 0139 | 84 | 10 kpl | TW 0315 | 82 | 250 szt. |
| | | TW 0066 | 80 | 1000 szt. | TW 0140 | 84 | 10 kpl | TW 0316 | 82 | 250 szt. |
| | | TW 0067 | 79 | 1000 szt. | TW 0141 | 84 | 10 kpl | TW 0317 | 82 | 250 szt. |
| | | TW 0068 | 77 | 1000 szt. | TW 0141.01 | 84 | 10 kpl | TW 0327 | 87 | 1000 szt. |
| | | TW 0069 | 76 | 1000 szt. | TW 0142 | 72 | 100 szt. | TW 0329 | 79 | 1000 szt. |
| | | TW 0071 | 78 | 1000 szt. | TW 0143 | 72 | 100 szt. | TW 0330 | 79 | 1000 szt. |
| | | TW 0072 | 78 | 1000 szt. | TW 0144 | 85 | 50 szt. | TW 0331 | 76 | 500 szt. |
| | | TW 0074 | 78 | 1000 szt. | TW 0151 | 85 | 50 szt. | TW 0332 | 72 | 320 szt. |
| | | TW 0075 | 78 | 1000 szt. | TW 0154 | 87 | 1000 szt. | TW 0333 | 77 | 500 szt. |
| | | TW 0076 | 89 | 250 szt. | TW 0155 | 88 | 5000 szt. | TW 0334 | 81 | 1000 szt. |
| | | TW 0077 | 89 | 250 szt. | TW 0156 | 88 | 5000 szt. | TW 0339 | 74 | 70 szt. |
| | | TW 0078 | 89 | 250 szt. | TW 0157 | 86 | 1000 szt. | TW 0344 | 89 | 1000 szt. |
| | | TW 0079 | 89 | 1000 szt. | TW 0158 | 76 | 500 szt. | TW 0346 | 81 | 300 szt. |
| | | TW 0080 | 89 | 1000 szt. | TW 0159 | 81 | 1000 szt. | TW 0356 | 74 | 200 szt. |

DESIGNER: panoramapress



Zakład Przetwórstwa Tworzyw Sztucznych

Halina Błażejowicz

Katarzynki 1, 87-200 Wąbrzeźno

tel. /fax +48 56 687 59 00;

+48 56 687 59 01; +48 56 688 67 03

e-mail: poczta@katarzynki.pl

www.katarzynki.pl